



IMPORTANT SAFETY PRECAUTIONS

Before you begin, read these instructions completely and carefully.

- Be certain electrical power is OFF before and during installation, maintenance and removal.
- Luminaire wiring must be properly grounded in accordance with the NEC and any applicable local code requirements.
- Use only UL or IEC approved wire for input/output connections.
- Verify that supply voltage matches voltage on luminaire label. Installation to any other connection may void the warranty.
- Wear gloves during installation to prevent injury and do not expose wiring to metal or sharp edges.
- Do not install in areas subject to combustible vapors or gases. Verify luminaire location ratings are suitable for installation environment (refer to specification sheet as needed).
- Do not restrict luminaire's ventilation by covering with material that will cause luminaire to overheat and potentially shorten the life span.
- Ensure LED luminaire has the correct polarity before installation.



WARNING: To reduce the risk of personal injury or property damage from fire, electrical shock, falling parts, abrasions, burns and all other hazards, read all provided warnings and follow installation instructions.

This product should be installed, inspected and maintained by a qualified and licensed electrician. Installation of luminaire must be in accordance with NEC and local code requirements.

SAVE THESE INSTRUCTIONS

FLEXIBLE CONDUIT ONLY

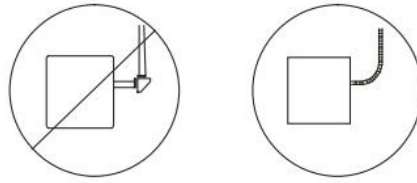

INSTALLATION INSTRUCTIONS (J-BOX MOUNTING)

- A) Feed fixture leads through the backplate and connect to AC power supply. (Figure 1)
- B) Connect wires through J-Box. Mount backplate on J-Box and secure with screws.
- C) Connect battery only after continuous AC power can be provided to the unit. (Figure 2)
- D) Align clips and push housing directly onto main bottom case. Apply continuous AC power and press "TEST" button to check the light. (Figure 3)
- E) Installation is complete. 

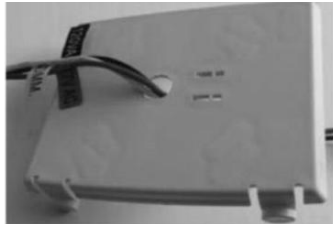

FIGURE 1

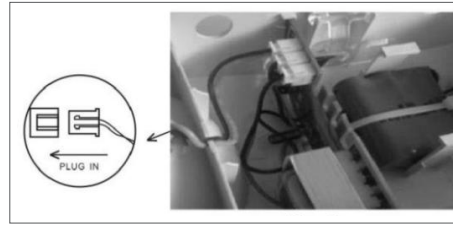

FIGURE 2

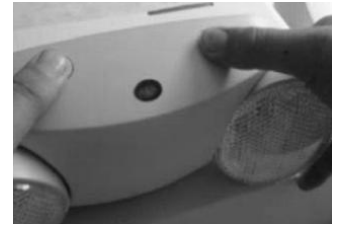

FIGURE 3

INSTALLATION INSTRUCTIONS (CONDUIT)

- A) Secure back plate to wall surface. Route wires through hole in conduit flange and make conduit connection.
- B) Connect battery only after continuous AC power can be provided to the unit (Figure 4).
- C) Align clips and push housing directly onto the backplate (Figure C). Apply continuous AC power and press "TEST" button to check the light.
- D) Installation is complete. 

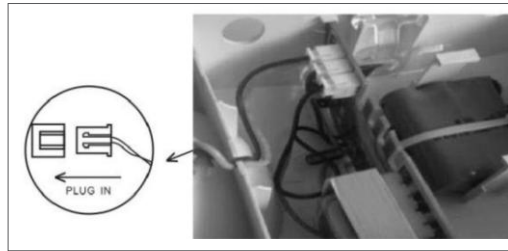
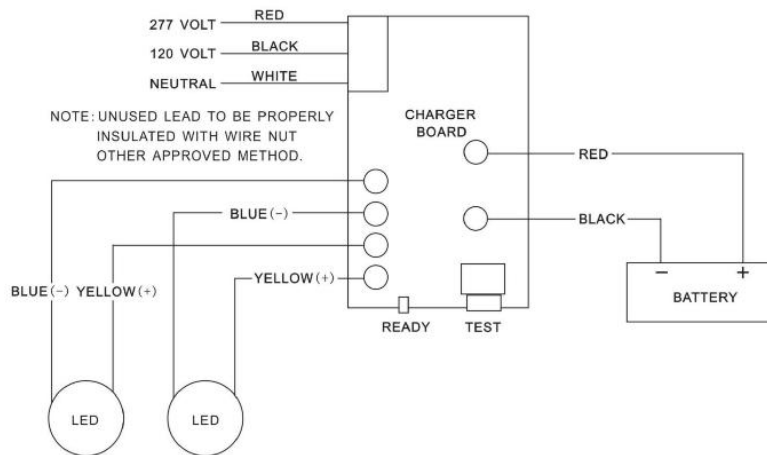

FIGURE 4



FIGURE 5

ELECTRICAL CONNECTIONS



SAVE THESE INSTRUCTIONS