



IMPORTANT SAFETY PRECAUTIONS

Before you begin, read these instructions completely and carefully.

- Be certain electrical power is OFF before and during installation, maintenance and removal.
- Luminaire wiring must be properly grounded in accordance with the NEC and any applicable local code requirements.
- Use only UL or IEC approved wire for input/output connections.
- Verify that supply voltage matches voltage on luminaire label. Installation to any other connection may void the warranty.
- Wear gloves during installation to prevent injury and do not expose wiring to metal or sharp edges.
- Do not install in areas subject to combustible vapors or gases. Verify luminaire location ratings are suitable for installation environment (refer to specification sheet as needed).
- Do not restrict luminaire's ventilation by covering with material that will cause luminaire to overheat and potentially shorten the life span.
- Ensure LED luminaire has the correct polarity before installation.



WARNING: To reduce the risk of personal injury or property damage from fire, electrical shock, falling parts, abrasions, burns and all other hazards, read all provided warnings and follow installation instructions.

This product should be installed, inspected and maintained by a qualified and licensed electrician. Installation of luminaire must be in accordance with NEC and local code requirements.

SAVE THESE INSTRUCTIONS



DIMENSIONS

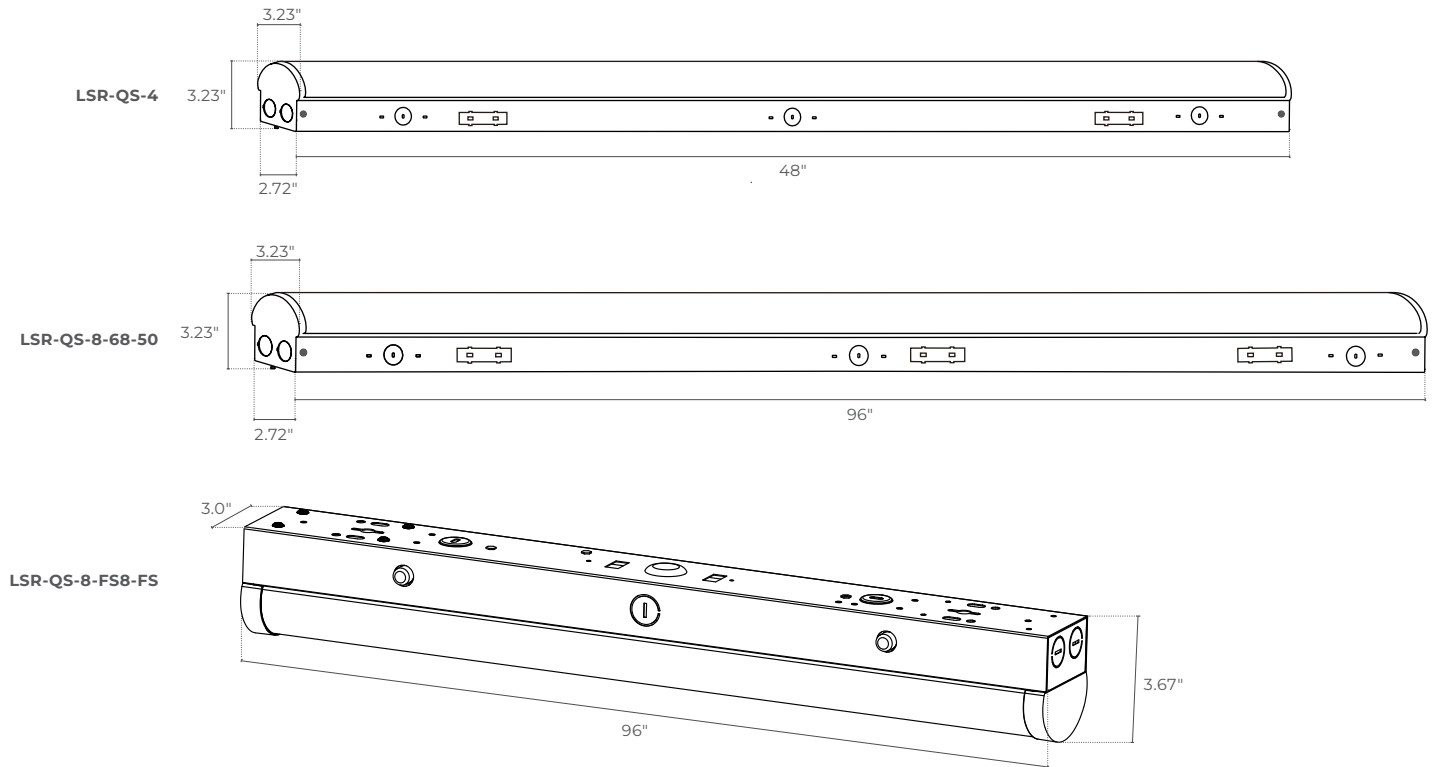

INSTALLATION INSTRUCTIONS (SUSPENDED)

A) Insert chain on each hook and insert hooks into the installation holes.

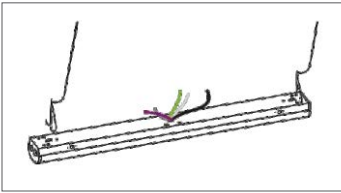

B) Attach the chains to the ceiling and adjust till balanced and secured.

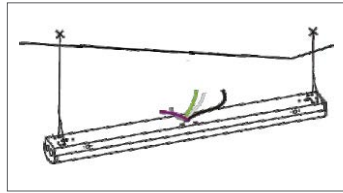

C) Make electrical connections.

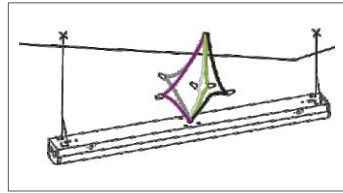

D) Feed wires into conduit.

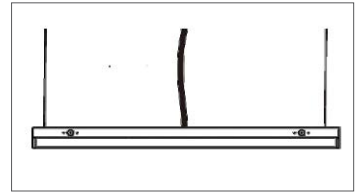

E) If using a connection plate for continuous runs, align connection plate on backside of fixtures as shown. Use screws to tighten.

Installation is complete. 

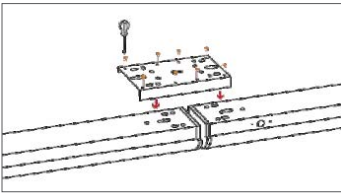

SAVE THESE INSTRUCTIONS



INSTALLATION INSTRUCTIONS (SURFACE MOUNT)

A) Secure mounting brackets to ceiling.
Ensure brackets are parallel and in 27" intervals.

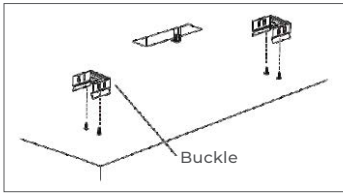

B) Make electrical connections.

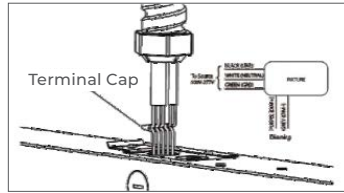

C) Snap fixture into place.

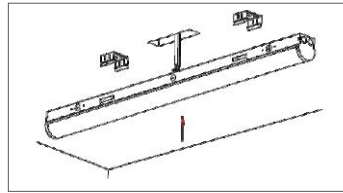

D) Installation is complete. 

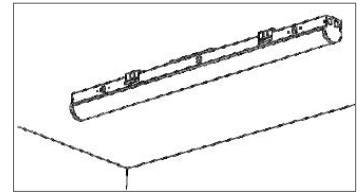

SAVE THESE INSTRUCTIONS

