



IMPORTANT SAFETY PRECAUTIONS

Before you begin, read these instructions completely and carefully.

- Be certain electrical power is OFF before and during installation, maintenance and removal.
- Luminaire wiring must be properly grounded in accordance with the NEC and any applicable local code requirements.
- Use only UL or IEC approved wire for input/output connections.
- Verify that supply voltage matches voltage on luminaire label. Installation to any other connection may void the warranty.
- Wear gloves during installation to prevent injury and do not expose wiring to metal or sharp edges.
- Do not install in areas subject to combustible vapors or gases. Verify luminaire location ratings are suitable for installation environment (refer to specification sheet as needed).
- Do not restrict luminaire's ventilation by covering with material that will cause luminaire to overheat and potentially shorten the life span.
- Ensure LED luminaire has the correct polarity before installation.



WARNING: To reduce the risk of personal injury or property damage from fire, electrical shock, falling parts, abrasions, burns and all other hazards, read all provided warnings and follow installation instructions.

This product should be installed, inspected and maintained by a qualified and licensed electrician. Installation of luminaire must be in accordance with NEC and local code requirements.

SAVE THESE INSTRUCTIONS



DIMENSIONS

Size 9

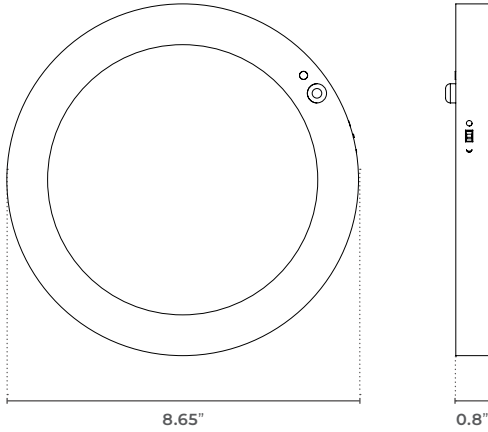

PACKAGE CONTENTS

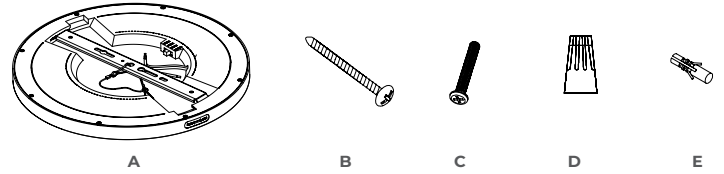

Part	Description	Qty
A	Fixture (with preassembled mounting strap)	1
B	Tapered self-tapping screw	4
C	Flat Screw	2
D	Wiring Cap	3
E	Wall Plug	4

INSTALLATION INSTRUCTIONS

1) Rotate the mounting strap (Part B) to detach it from the lamp body (Part A).

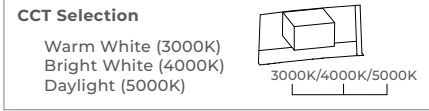
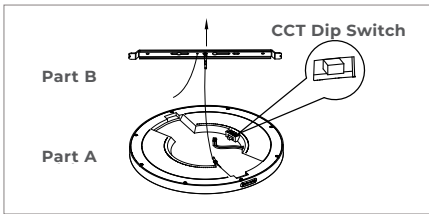

2) Install the mounting strap to the ceiling.

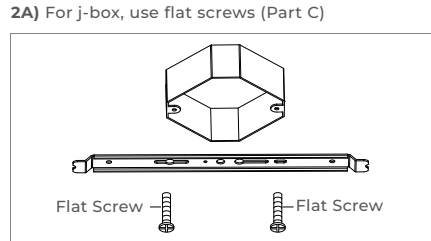

2B) For solid ceiling, use tapered self-tapping screws (Part B) and wall plugs (Part E)

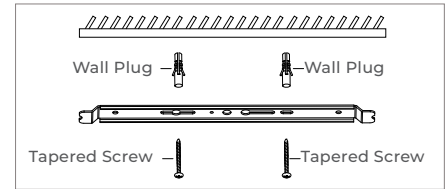

3) Connect lamp body to mounting strap with safety rope and make connections with wiring caps (D). Carefully place all the wires and wire connections into the j-box.

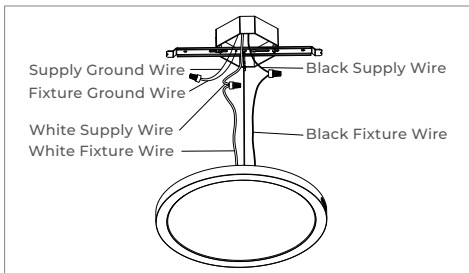

4) Align the two slots on the lamp body with the two ends of the mounting strap and twist lamp body clockwise to secure.

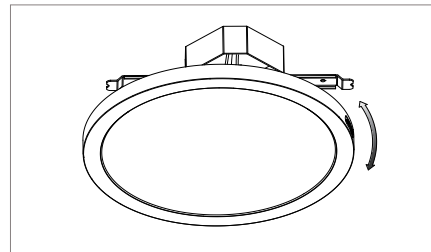

5) Installation is complete.

PIR SENSOR FUNCTION

Auto-on when motion is detected within 10-15 ft. Auto-off when no motion is detected after 30 seconds.

SAVE THESE INSTRUCTIONS

