



IMPORTANT SAFETY PRECAUTIONS

Before you begin, read these instructions completely and carefully.

- Be certain electrical power is OFF before and during installation, maintenance and removal.
- Luminaire wiring must be properly grounded in accordance with the NEC and any applicable local code requirements.
- Use only UL or IEC approved wire for input/output connections.
- Verify that supply voltage matches voltage on luminaire label. Installation to any other connection may void the warranty.
- Wear gloves during installation to prevent injury and do not expose wiring to metal or sharp edges.
- Do not install in areas subject to combustible vapors or gases. Verify luminaire location ratings are suitable for installation environment (refer to specification sheet as needed).
- Do not restrict luminaire's ventilation by covering with material that will cause luminaire to overheat and potentially shorten the life span.
- Ensure LED luminaire has the correct polarity before installation.



WARNING: To reduce the risk of personal injury or property damage from fire, electrical shock, falling parts, abrasions, burns and all other hazards, read all provided warnings and follow installation instructions.

This product should be installed, inspected and maintained by a qualified and licensed electrician. Installation of luminaire must be in accordance with NEC and local code requirements.

SAVE THESE INSTRUCTIONS



DIMENSIONS

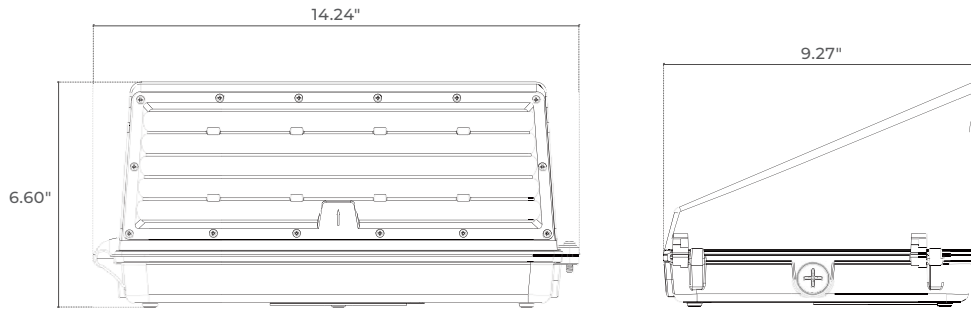

INSTALLATION INSTRUCTIONS

1) Use a screwdriver to unscrew the fixture screws and remove the upper half of the fixture.

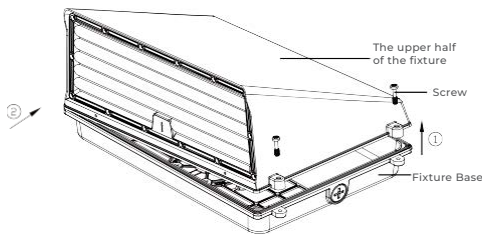

2) Unscrew the cover of the entry hole on the fixture base and remove the cover.

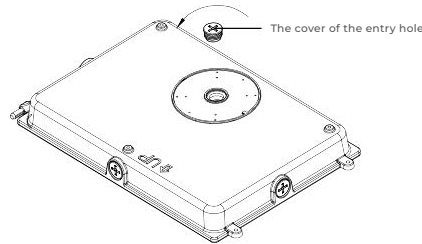

3) Make desired mounting holes.

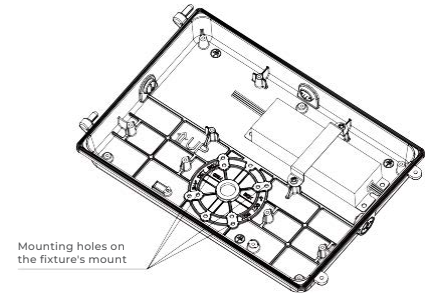

4) Bring power feed through the back box.

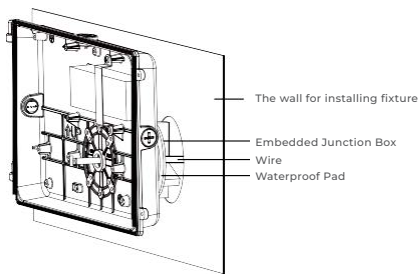

5) Use screws to secure the fixture base to the back box.

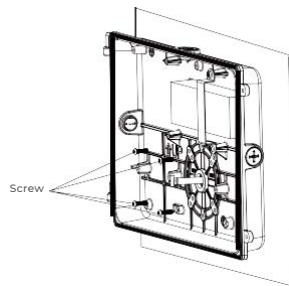

6) Make wiring connections and place in back box.

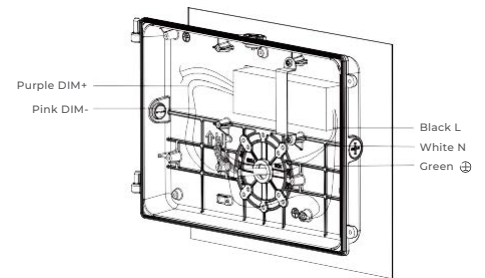

7) Connect the two low voltage wires from driver to LED PCB.

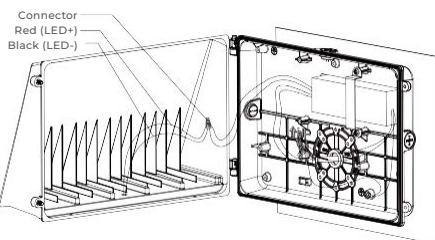

8) Close cover and secure with screws.

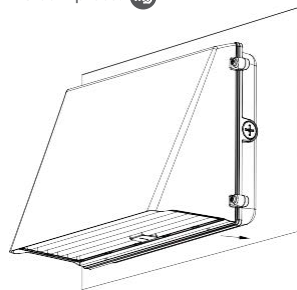

SAVE THESE INSTRUCTIONS

