

PROJECT DATE

COMMENTS



SPECIFICATIONS

Material	Steel
Mounting	Anchor Bolts
Pole Diameter	4" or 5"
Gauge	0.125" (11 Gauge)
Finish	Bronze

SIZE CHART

POLE DIAMETER inches	POLE HEIGHT feet	GAUGE	WALL THICKNESS inches	BOLT CIRCLE inches	SQUARE BASE PLATE inches
4	12	9	0.119	9	10.5
4	15	9	0.119	9	10.5
4	17	9	0.119	9	10.5
4	20	9	0.119	9	10.5
4	25	9	0.119	9	10.5
5	30	11	0.119	11	11
5	30	11	0.179	11	11



ORDERING LOGIC

EX: SSS-4-12-11-BZ

FAMILY	POLE DIAMETER		POLE HEIGHT		WALL THICKNESS		FINISH		ACCESSORIES	
SSS							BZ	Bronze		
	4	4"	12	12'	19	0.119"	BZ	Bronze	SSVT	Single Square Vertical Tenon
			15	15'	79	0.179" 5" DIAMETER ONLY			TSHT180	180° Twin Square Horizontal Tenon
			17	17'					TST90	90° Twin Square Tenon
			20	20'					THT90	90° Triple Horizontal Tenon
			25	25'					QSHT90	90° Quad Square Horizontal Tenon
	5	5"	30	30'					TLT30	30" Triple In-Line Tenon
									TST	Twin Square Tenon
									QST	Quad Square Tenon
									TBHT180	180° Triple Bullhorn Tenon
									DBHT180	180° Double Bullhorn Tenon
									CC	Custom Configurations FOR ADDITIONAL OPTIONS CONTACT SALES@SAGE.LIGHTING

INCLUDED ACCESSORIES

ANCHOR BOLTS

BASE PLATE COVER

POLE CAP (BLACK)

HAND HOLE COVER

TEMPLATE

12 PLUGS

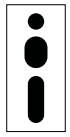
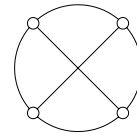
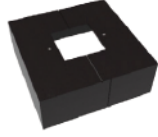

DIMENSIONS

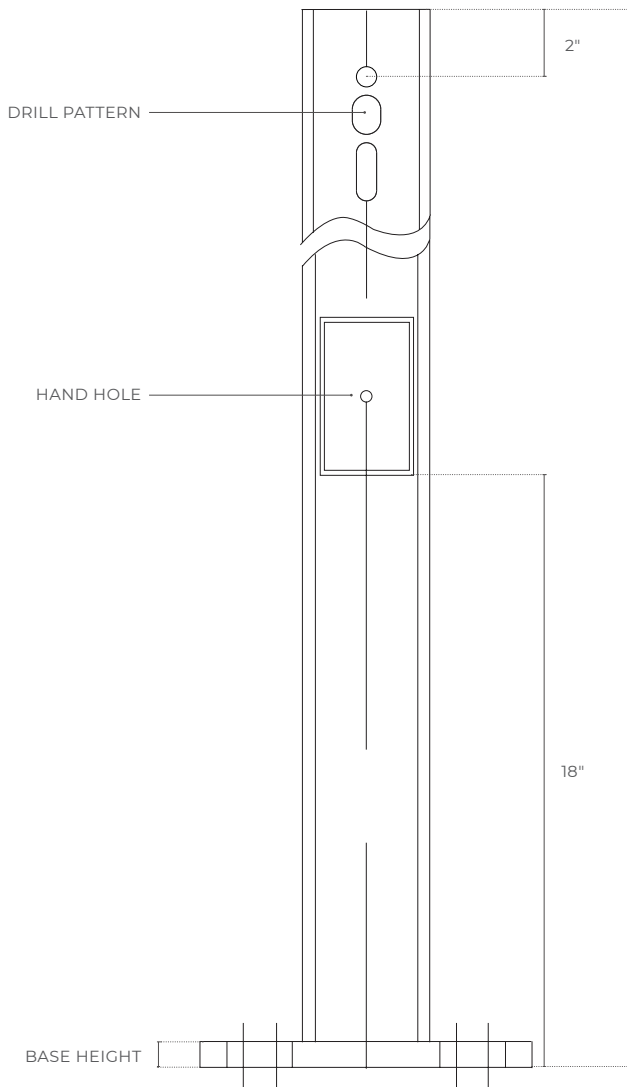

DRILL PATTERN (TOP OF POLE)

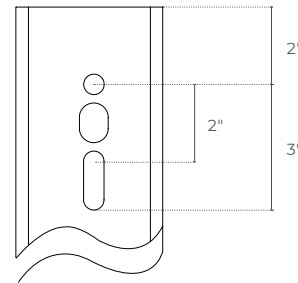

HAND HOLE COVER

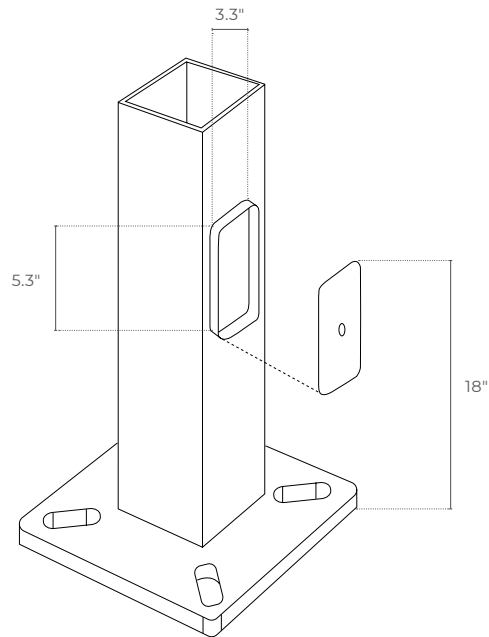
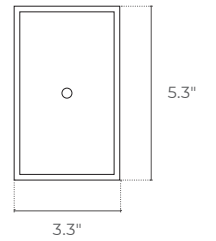

DIMENSIONS (CONTINUED)

4" POLE SHAFT

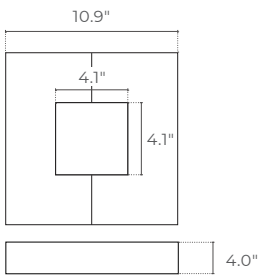
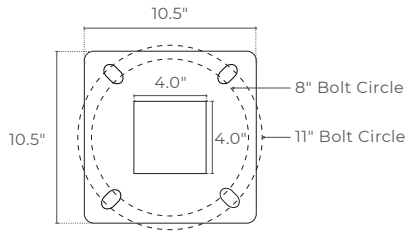

Base Plate Cover Included
Packaged Separately

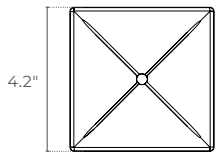

Pole Cap Included

5" POLE SHAFT

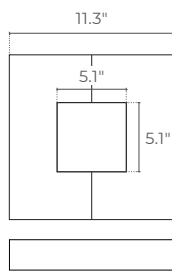
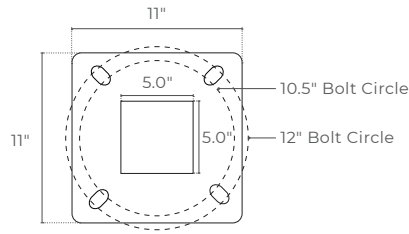

Base Plate Cover Included
Packaged Separately

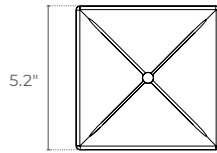

Pole Cap Included

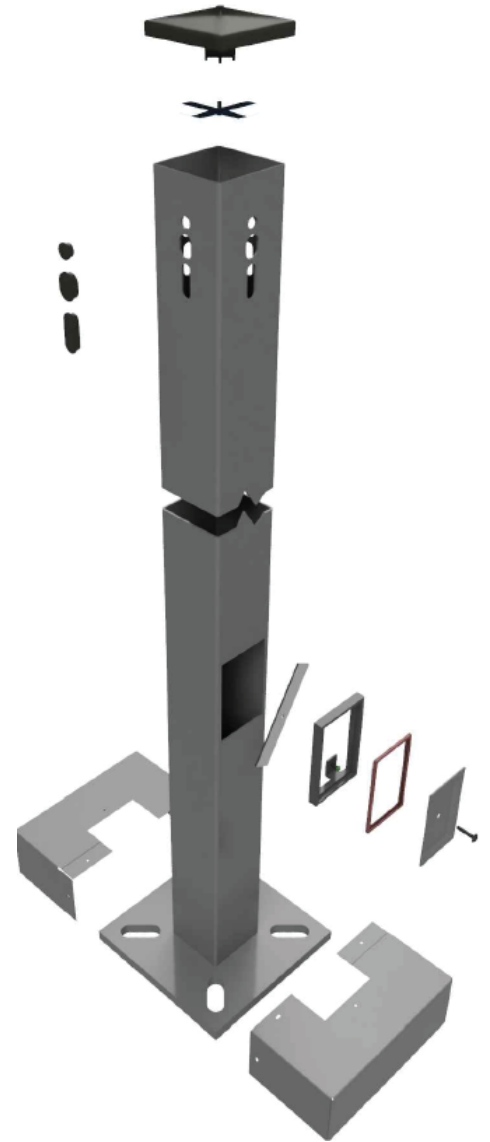

ANCHOR BOLTS

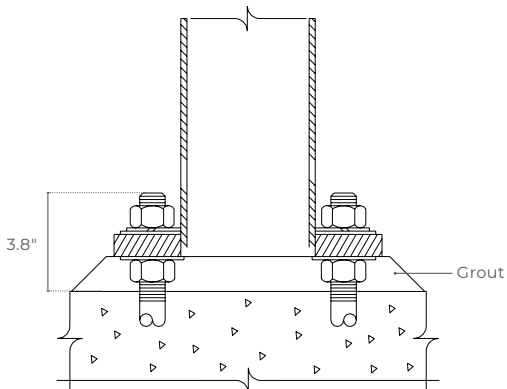

MOUNTING ACCESSORIES

SSVT

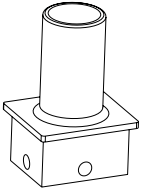

TSHT180

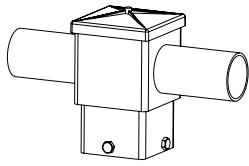

TST90

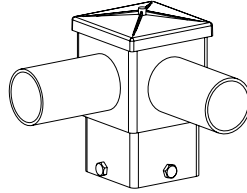

THT90

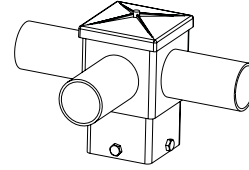

QSHT90

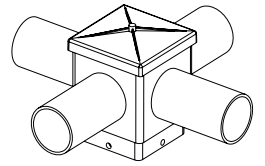

TLT30

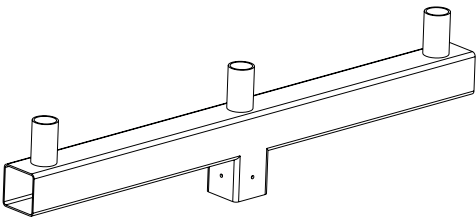

TST

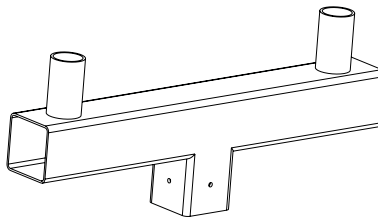

QST

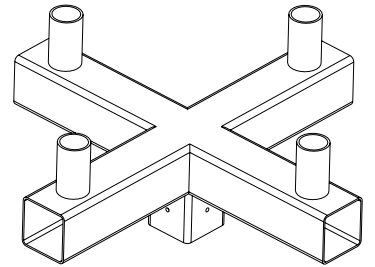

TBHT180

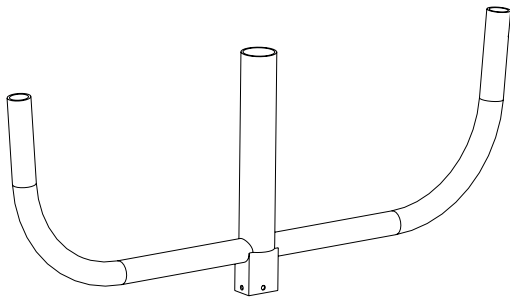

DBHT180

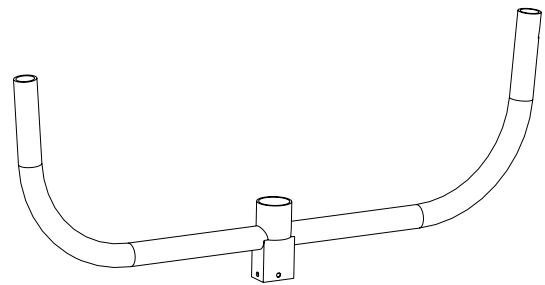

ALLOWABLE WIND LOADING

WIND MAP

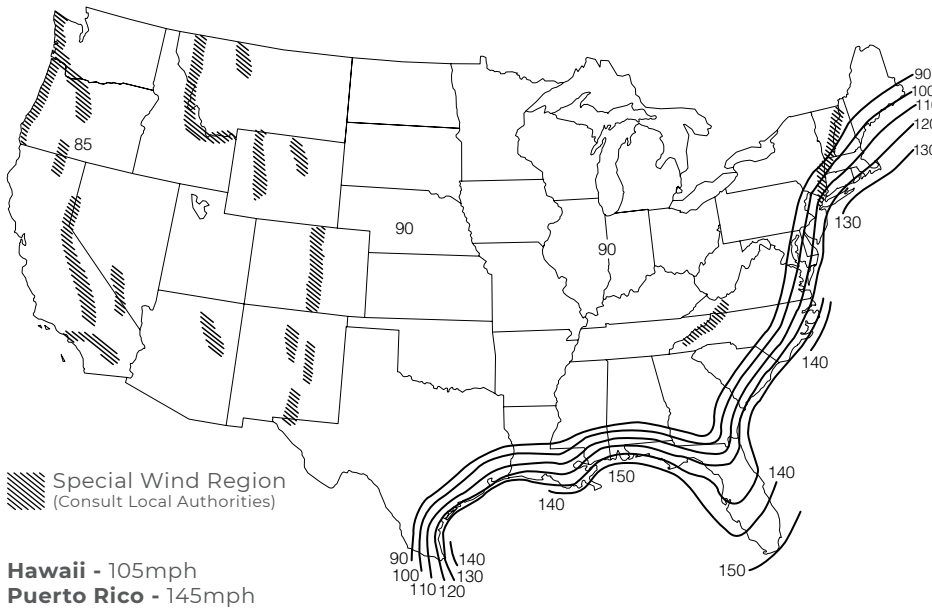

FLORIDA REGION WIND MAP

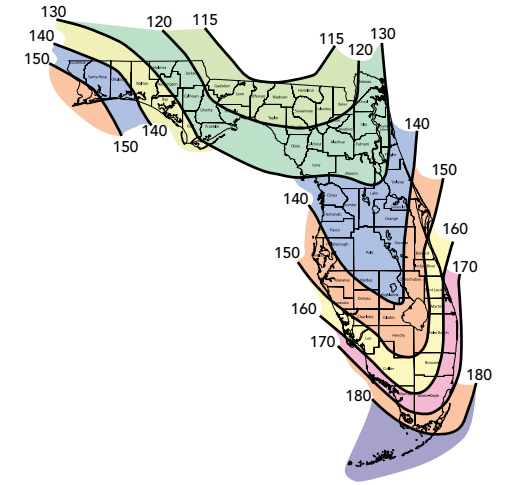

Florida region wind map above is based upon 3-second gust winds and the 2017 Florida Building Code

ORDERING NUMBER	POLE HEIGHT feet	90 MPH EPA (ft ²)	100 MPH EPA (ft ²)	110 MPH EPA (ft ²)	120 MPH EPA (ft ²)	130 MPH EPA (ft ²)	150 MPH EPA (ft ²)	ANCHOR BOLT	
								Diameter (in)	Length (in)
SSS-4	15	12.0	12.0	12.0	9.8	7.8	4.9	0.75	30
SSS-4	17	12.0	12.0	9.9	7.6	5.9	3.3	0.75	30
SSS-4	20	12.0	9.1	6.7	4.8	3.4	1.3	0.75	30
SSS-4	25	7.0	4.6	2.7	1.3	0.3	-	0.75	30
SSS-5	30	5.6	2.7	0.6	-	-	-	1.00	36
SSS-5	30	11.7	7.8	4.8	0.8	0.8	-	1.00	36