

PROJECT DATE

COMMENTS



IN STOCK



FPS FLAT PANEL SURFACE LED

The FPS flat panel is a versatile product at less than 11/16" overall depth with integral dimmable driver. FPS is the ideal solution when designing with a low ceiling height and is perfect for overcrowded plenums. When recessed mounting is not an option, the FPS looks and plays the part excellently.

PHYSICAL

Material	Aluminum
Mounting	Surface (Ceiling, Wall)
Lens	PMMA
Finish	White

PERFORMANCE

Warranty	5 years
Certifications	Damp Location, UL, cUL, DLC Standard
Rated Life	L70 >50,000 hours
THD	<20%
CCT	Field Selectable: 3000K, 4000K, 5000K
CRI	80+
Beam Angle	>120°

ENERGY CHART

SIZE	DIMENSIONS feet	DELIVERED LUMENS	WATTAGE	EFFICACY lm/w
14	1 X 4	2200/3300/4400	20/30/40	110
22	2 X 2	2200/3300/4400	20/30/40	110
24	2 X 4	3300/4400/5500	30/40/50	110

ELECTRICAL

Wattage	Field Selectable: 20W/30W/40W, 30W/40W/50W
Voltage	100-277V
Power Factor	>0.9
Dimmable	1-10V

ORDERING LOGIC

EX: FPS-14-FS1-SM

FAMILY	SIZE
FPS	
	14 1' X 4'
	22 2' X 2'
	24 2' X 4'

ACCESSORIES ORDERING LOGIC (ORDER SEPARATELY)

EX: FPS-EM

FAMILY	ACCESSORIES
FPS	
	EM Emergency Backup: 120 minutes TO BE FIELD INSTALLED

SPECIFICATIONS

CONSTRUCTION

Extruded aluminum housing.

ELECTRICAL

LED Driver: Internal driver makes the panel only 0.68" thickness

Dimming: Powered by high efficiency LED driver, with a standard 1-10V driver which continuous dims to 10% that works with many types of controls. Tested Dimmers: Lutron ® Diva-Dvtv, Leviton ® IP-710-DL.

THD: <20%

Power Factor: >0.9

Input Voltage: Standard electronic driver is UL recognized and available for 100-277V AC.

LED SYSTEM

CRI: Minimum 80 color rendering index

CCT: CCT adjustable from 3500K, 4000K and 5000K with a great color consistency

LED: Life Minimum 50,000h with 87.8% of lumen maintenance in 25°C ambient temperature, in compliance with IES LM-80 testing measurements.

Thermal Management: Aluminum housing acting as the heat sink to maximize life.

MOUNTING

Surface mounted or recessed

APPROVALS

- cULus listed for damp locations
- Tested to IESNA LM-79 and LM-80
- DesignLights Consortium Qualified and classified for DLC Standard, refer to www.designlights.org for details
- 5-year Limited Warranty

OPTION FUNCTION

Emergency Option: Optional high voltage 8W emergency LED driver EM-H08170-LBF can be provided. When AC power fails, it immediately switches to the emergency mode, operating for lighting up to 120 minutes. When AC power is restored, it automatically returns to the charging mode which meets critical life-safety lighting requirements.

For more info or spec sheet, please contact sales.

EMERGENCY LUMEN OUTPUT

FIXTURE EFFICACY	OUTPUT POWER 8W
110 lm/w	880 Lumens

DIMENSIONS

2x2

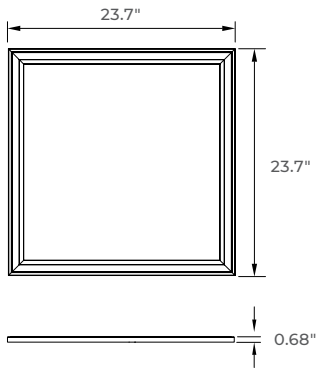

2x4

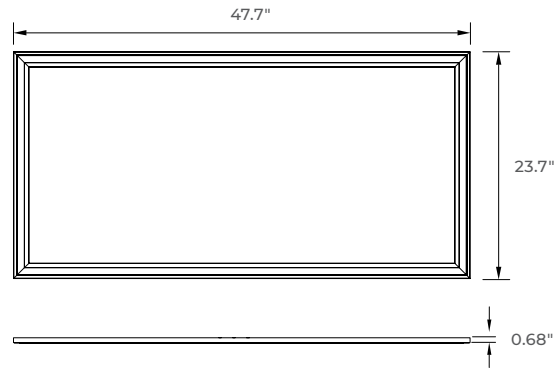

1x4

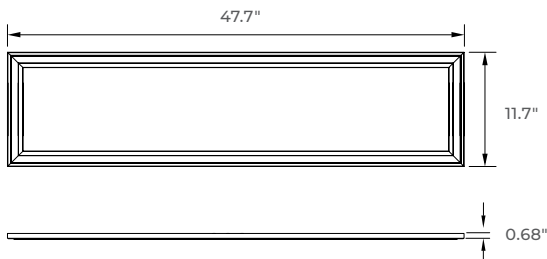

MOUNTING

SM SURFACE

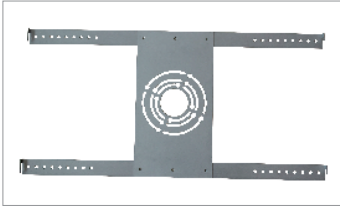

Surface Mounting Kit

This metal plate is equipped with screw holes for bolting to the ceiling, and 4 small static corner hooks on the mounting plate.

Internal Driver And Slotted Design Compatible With Multiple Size Of Junction Boxes

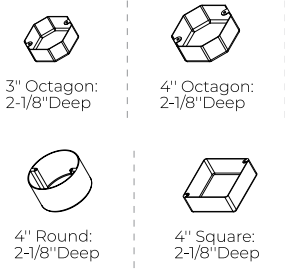

ACCESSORIES

EM Emergency Backup: 120 minutes

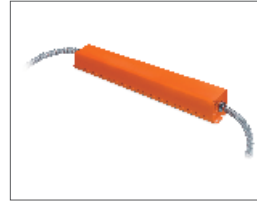

Optional high voltage 8W emergency LED driver EM-H08170-LBF can be provided. When AC power fails, it immediately switches to the emergency mode, operating for lighting up to 120 minutes. When AC power is restored, it automatically returns to the charging mode which meets critical life-safety lighting requirements.

For more info or spec sheet, please contact sales.

EMERGENCY LUMEN OUTPUT

FIXTURE EFFICACY	OUTPUT POWER 8W
110 lm/w	880 Lumens

ADDITIONAL PHOTOS

2x2



2x4



1x4



PHOTOMETRICS - 2X2-40W-3500K

AVERAGE BEAM ANGLE (50%): 112.7°

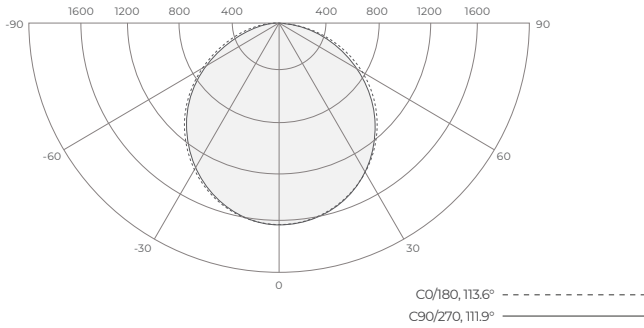

LUMINANCE cd/(m2)

G(DEG)	C0/180	C90/270
85	6913	6899
80	9835	9454
75	11668	11239
70	12851	12466
65	13700	13340
60	14279	13982
55	14687	14438
50	14998	14798
45	15229	15072

ZONAL FLUX DIAGRAM

T	C0	C45	C90	C135	C180
10	1570	1571	1572	1572	1572
20	1489	1490	1490	1492	1492
30	1356	1358	1356	1361	1362
40	1181	1180	1172	1183	1186
50	964.2	960.4	951.7	963.6	969.4
60	714.1	707.3	699.5	711.2	719.6
70	439.6	433.4	426.6	437.1	445.5
80	170.8	168.9	164.3	172.1	176.7
90	1.247	1.298	1.195	1.402	0.8306
100	1.243	1.246	1.141	1.351	0.9367
110	2.334	2.077	1.819	2.026	1.713
120	2.855	2.545	2.235	2.597	2.284
130	3.271	2.648	3.327	2.597	2.337
140	3.271	1.870	3.378	1.924	2.442
150	2.959	1.299	2.807	1.299	2.909
160	2.336	1.299	2.807	1.350	3.272
170	3.271	1.818	3.119	2.129	3.480
180	3.323	2.026	3.742	2.441	3.272
DEG	LUMINOUS INTENSITY: cd				

ZONAL LUMENS

T	φ TOTAL
0-10	151.2
10-20	584.8
20-30	1243
30-40	2039
40-50	2865
50-60	3611
60-70	4174
70-80	4485
80-90	4557
90-100	4558
100-110	4560
110-120	4562
120-130	4564
130-140	4566
140-150	4568
150-160	4569
160-170	4570
170-180	4570
	UNIT: lm

PHOTOMETRICS - 2X4-50W-3500K

AVERAGE BEAM ANGLE (50%): 113.1°

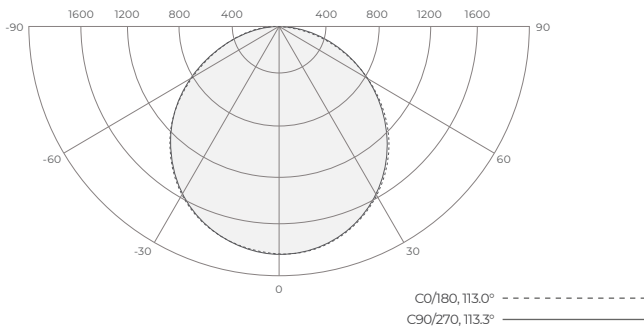

LUMINANCE cd/(m2)

G(DEG)	C0/180	C90/270
85	8132	9735
80	11139	12083
75	13106	13631
70	14458	14829
65	15410	15705
60	16083	16349
55	16585	16831
50	16969	17184
45	17249	17452

ZONAL FLUX DIAGRAM

T	C0	C45	C90	C135	C180
10	1788	1795	1792	1789	1787
20	1694	1706	1703	1696	1692
30	1542	1557	1556	1547	1541
40	1339	1355	1353	1346	1339
50	1090	1104	1104	1098	1092
60	804.0	815.3	817.0	812.5	809.2
70	494.4	503.2	506.9	503.8	500.7
80	193.4	203.9	209.7	207.1	203.7
90	1.005	1.356	1.810	1.450	0.8329
100	0.7091	1.207	1.708	1.192	0.7828
110	1.199	1.721	1.863	1.711	1.216
120	1.719	1.935	1.035	1.870	1.594
130	1.721	1.669	0.9820	1.740	1.774
140	1.722	0.9395	0.9821	1.141	2.079
150	1.670	1.194	0.9822	0.9327	2.153
160	1.541	1.321	1.109	0.9329	2.205
170	2.050	1.430	1.559	1.399	2.468
180	2.242	1.565	1.758	1.292	2.294
DEG	LUMINOUS INTENSITY: cd				

ZONAL LUMENS

T	φ TOTAL
0-10	172.1
10-20	665.9
20-30	1416
30-40	2324
40-50	3268
50-60	4121
60-70	4769
70-80	5135
80-90	5227
90-100	5229
100-110	5230
110-120	5232
120-130	5233
130-140	5235
140-150	5236
150-160	5236
160-170	5237
170-180	5237
	UNIT: lm

PHOTOMETRICS - 1X4-40W-3500K

AVERAGE BEAM ANGLE (50%): 113.3°

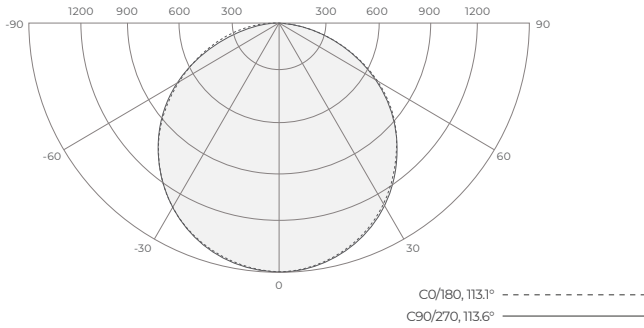

ZONAL FLUX DIAGRAM

ZONAL LUMENS

T	C0	C45	C90	C135	C180
10	1471	1475	1473	1473	1473
20	1393	1400	1400	1397	1397
30	1267	1277	1279	1273	1273
40	1099	1109	1113	1107	1105
50	894.8	903.0	909.2	903.3	902.1
60	662.7	669.4	677.5	671.8	669.4
70	409.6	419.8	429.1	423.2	416.2
80	162.8	176.1	189.3	177.8	170.2
90	0.7842	1.055	1.939	1.147	0.6840
100	0.5478	0.7790	2.121	0.9502	0.6840
110	0.9572	1.414	2.280	1.459	1.094
120	1.414	2.174	1.356	2.175	1.460
130	1.572	2.198	1.128	2.259	1.733
140	1.696	2.213	1.128	2.265	1.915
150	1.865	2.447	1.263	2.401	2.197
160	1.939	3.111	1.430	3.080	2.245
170	2.824	3.939	1.714	3.851	2.737
180	3.010	4.034	1.714	3.896	2.918
DEG	LUMINOUS INTENSITY: cd				

T	φ TOTAL
0-10	141.7
10-20	548.2
20-30	1166
30-40	1912
40-50	2689
50-60	3392
60-70	3930
70-80	4240
80-90	4320
90-100	4322
100-110	4323
110-120	4325
120-130	4327
130-140	4328
140-150	4330
150-160	4331
160-170	4332
170-180	4332
	UNIT: lm

LUMINANCE cd/(m2)

G(DEG)	C0/180	C90/270
85	6895	9294
80	9377	10893
75	10922	11833
70	11977	12535
65	12751	13101
60	13256	13539
55	13633	13878
50	13922	14133
45	14161	14345