



INTERIM TEMP. LIGHTING

PROJECT _____ DATE _____

COMMENTS _____



ADJUSTABLE TRIPOD



SUSPENDED

ENERGY CHART

DELIVERED LUMENS	WATTAGE	EFFICACY lm/w	FIXTURES PER CIRCUIT	
			20A	15A
39,000	300	130	6	4

ORDERING LOGIC

EX: STAR-300

FAMILY	WATTAGE
STAR	300
	300 300W

STAR TEMPORARY PENDANT/PORTABLE LED

The STAR Series offers a 300W mobile, durable, and high impact fixture perfect for illuminating large open spaces with high ceilings.

- Road Construction
- Construction Sites
- General Industrial / Maintenance Programs

PHYSICAL

Operating Temperature	-40°C to 50°C (-40°F to 122°F)
Mounting	Portable: Adjustable Tripod / Suspended
Lens	Opal Cover
Finish	Black
Weight	15.43 lbs
Cable Gauge	14AWG *Different Gauge Wire Available Upon Request

PERFORMANCE

Warranty	5 years
Certifications	ETL
IP Rating	IP65
IK Rating	IK08
Rated Life	50,000 hours
CCT	5000K
Beam Angle	100°
Max Run Length (14AWG)	320ft

ELECTRICAL

Wattage	300W
Voltage	100-277V
Power Factor	>0.9

ACCESSORIES ORDERING LOGIC (ORDER SEPARATELY)

EX: STAR-TR

FAMILY	OPTIONS
STAR	
TR	Tripod <small>INCLUDES SET OF 4 SAFETY CABLES</small>
CC	Rolling Carrying Case
TC	5' T-Trunk Cable
PC	120V Power Cord Adapter, LLT 3P M to NEMA 5-15R
20JC	20' Jumper Cable
PA	Plug Adapter, LLT 3P F to NEMA 5-15P Adapter



DIMENSIONS

Bottom

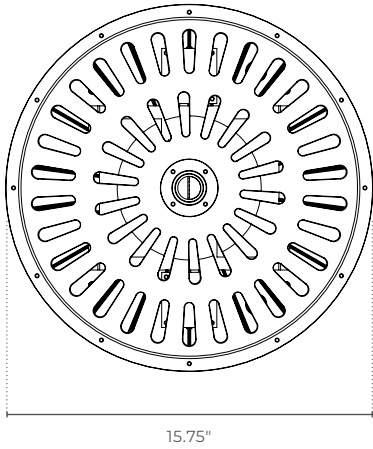

Side

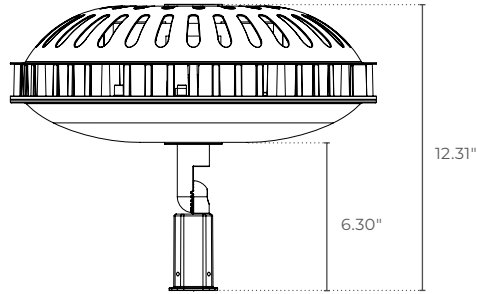

Top

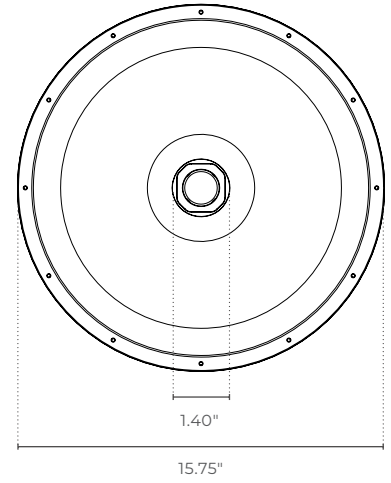

Tripod Dimensions



Suspended Mounting Diagram

* Hanging chain, ceiling hook, or structure is not included and provided by others.

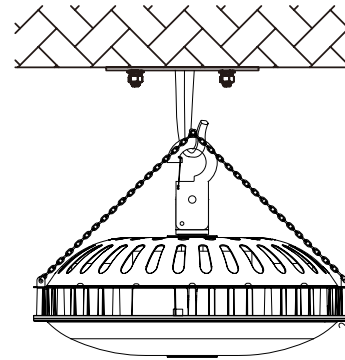

PHOTOMETRICS

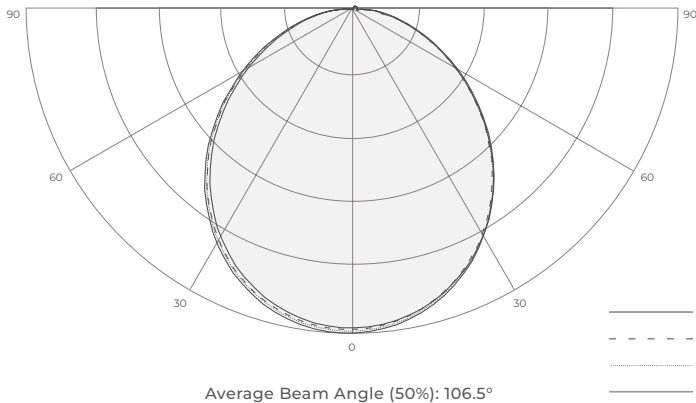

STAR-300 PER CIRCUIT

20A: 6
15A: 4



ACCESSORIES

STAR-CC Rolling Carrying Case



STAR-TR Tripod



STAR-TC 5' Trunk Cable

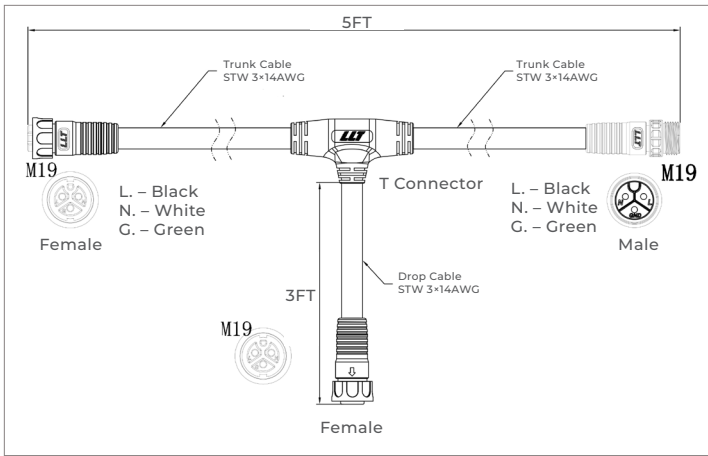

STAR-PC 120V Power Cord Adapter, LLT 3P M to NEMA 5-15R

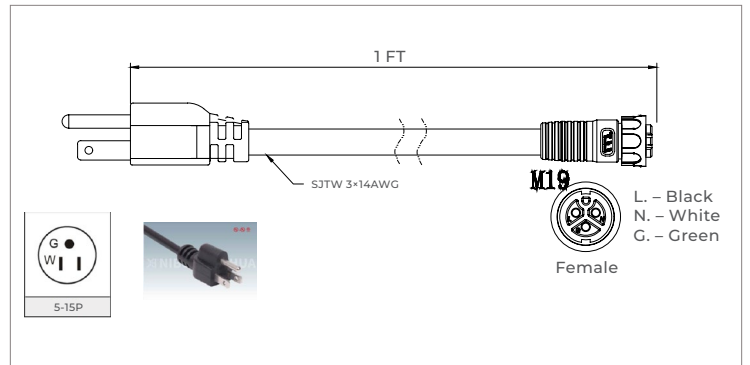

STAR-20JC 20' Jumper Cable

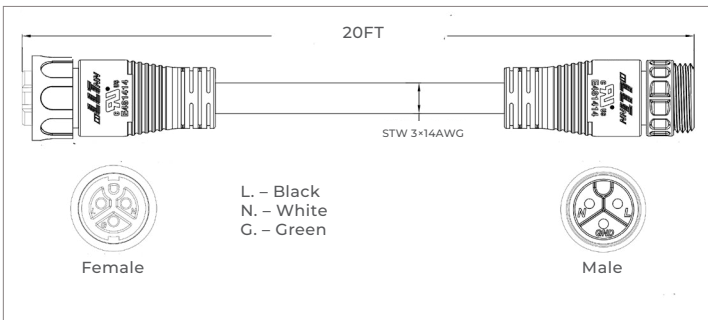

STAR-PA Plug Adapter, LLT 3P F to NEMA 5-15P Adapter

