

PROJECT DATE

COMMENTS



ENERGY CHART

SIZE	HEIGHT inches	WIDTH inches	DELIVERED LUMENS	WATTAGE	EFFICACY lm/w
42	9.27	14.24	5460	42	130
60			7800	60	130
80			10400	80	130
100			13000	100	130
120			15600	120	130
FS1			5400/6750/8100	40/50/60	135
FS2			8100/10800/13500	60/80/100	135

WPFC-G2 WALL PACK FULL CUTOFF LED GEN 2

The WPFC-G2 Series Wall Pack offers an IP65 wet location rated outdoor LED luminaire with optional photocell, motion sensor, and emergency battery.

- Parking Lots
- Underpasses
- Perimeter / Area Lighting

PHYSICAL

Material	Die-Cast Aluminum
Mounting	Wall Mount
Lens	Polycarbonate
Finish	Bronze, Black

PERFORMANCE

Warranty	5 years
Certifications	UL, cETLus, DLC Premium, Wet Location
IP Rating	IP65
CCT	3000K, 4000K, Field Selectable: 3000K/4000K/5000K
CRI	80+

ELECTRICAL

Wattage	42W, 60W, 80W, 100W, 120W Field Selectable: (40W/50W/60W), (60W/80W/100W)
Voltage	100-277V
Dimmable	0-10V

ORDERING LOGIC

EX: WPFC-G2-42-30-BK

FAMILY	WATTAGE	CCT	FINISH
WPFC-G2	42	30	BK Black
	60	40	BZ Bronze
	80		
	100		
	120		
	FS1	FS	
	FS2		

ACCESSORIES ORDERING LOGIC (ORDER SEPARATELY)

EX: WPFC-G2-PC

FAMILY	ACCESSORIES
WPFC-G2	PC* Photocell
	OS* Occupancy Sensor
	EM8 8W Emergency Battery
	EM18 18W Emergency Battery

ORDERING NOTES

- * OS and PC can be specified together for dual functionality (i.e. OS-PC)



DIMENSIONS

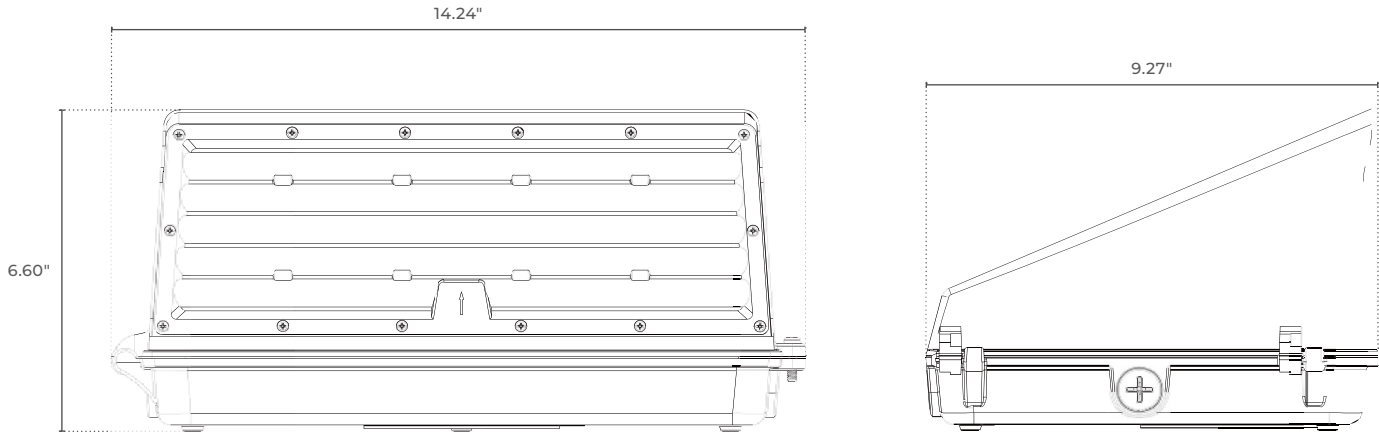

PHOTOMETRICS

AVERAGE BEAM ANGLE (50%): 97.2°

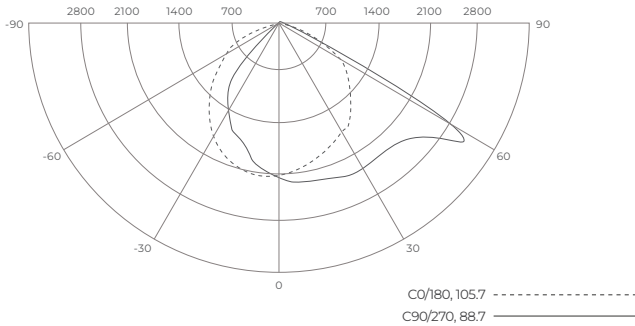

ADDITIONAL IMAGERY

EMERGENCY BATTERY



BI-LEVEL SENSOR



Sensor



Remote Control

SPECIFICATIONS

Power Supply	12V-24V DC, >50mA
Dim Control Output	0-10V, max. 25mA sinking current
HF System	5.8GHz ± 75MHz
Transmission Power	<0.2mW
Detection Radius	20% / 50% / 75% / 100% (1-8m)
Mounting Height	Max 40ft (12 meters)
Time Setting	10s / 1min / 5min / 10min / 15min / 20min / 30min / 60min
Light Control	24H / 10LUX / 30LUX / 50LUX
Operating Temperature	-4°F - 140°F (-20°C - 60°C)
IP Rating	IP65

DIMENSIONS

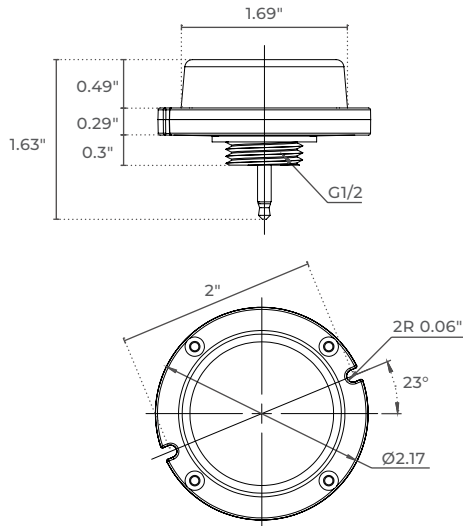

SENSOR COVERAGE

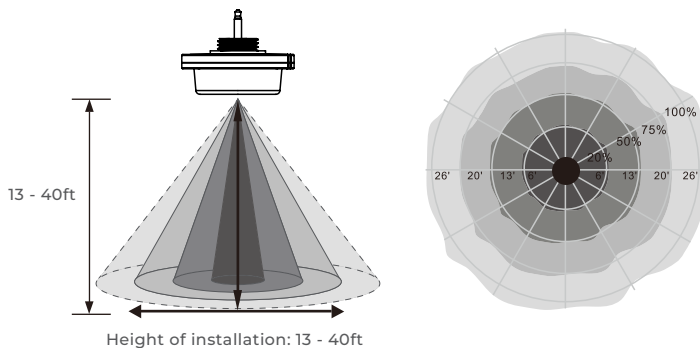

NOTES

GENERAL

- Sensor uses microwave sensing technology that reacts to movement within the coverage area
- Sensor must see direct movement of a person or moving object within the coverage area to detect them
- Careful consideration must be given to sensor luminaire placement
- Avoid placing the sensor where obstructions may block the sensor's line of sight
- Once the sensor stops detecting movement and the time delay elapses the luminaire will go from high to low mode and eventually turn off if desired

WARM-UP:

After the luminaire and sensor are connected to input power for the first time the luminaire will stay on for 15 seconds then proceed with normal operation per factory default settings

FACTORY DEFAULT SETTINGS:

- 100% Sensitivity
- Hold Time: 5 minutes
- Photocell / Daylight Sensor: OFF
- Dimming Level: 30%
- Dimming Time: 60 minutes

REMOTE CONTROL:

Every luminaire ordered with a sensor is provided with a remote control which can change all settings.

- Brightness – 70%, 80%, 90%, 100%
- Sensitivity – 20%, 50%, 75%, 100%
- Hold Time – 10sec, 1min, 5min, 10min, 15min, 20min, 30min, 60min
- Daylight Sensor Threshold – Set to Surrounding Ambient Light Level, 10lux/1fc, 30lux/3fc, 50lux/5fc, 100lux/10fc, 300lux/30fc, 500lux/50fc
- Stand-By or Bi-Level Dimming Setting – 0%, 10%, 30%, 50%
- Stand-By or Bi-Level Hold Time – Infinity, 1min, 30min, 60min

DIMMING FUNCTION:

The sensor can provide bi-level control for areas which require a low light level setting before switching completely off. There are 2 periods of selectable waiting time: motion/occupancy hold time and stand-by period.

PHOTOCELL:

The sensor has a selectable daylight threshold or the sensor can read the surrounding ambient light level and set as the daylight threshold.



BI-LEVEL SENSOR (CONTINUED)

DIMMING FUNCTION

This function inside the motion sensor to achieve tri-level control, for some areas which require a light change notice before switch-off. The sensor offers 3 levels of light: 100% → dimmed light (natural light is insufficient) → off; and 2 periods of selectable waiting time: motion hold-time and stand-by period; Selectable daylight threshold and freedom of detection area



With sufficient natural light, the light does not switch on when presence is detected.



With insufficient natural light, the sensor switched on the light automatically when presence is detected.



After hold-time, the light dims to stand-by level if the surrounding natural light is below the daylight threshold.



Light switches off automatically after the stand-by period elapses.

DAYLIGHT HARVESTING FUNCTION (ONLY ACCESSIBLE ON REMOTE CONTROL)

Open the daylight harvesting function only by choosing "👁️" when remote control is in setting condition. Memory and maintain current ambient brightness.

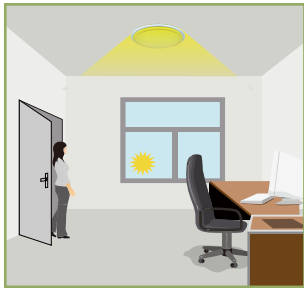

When the natural light is sufficient or dark, movement is detected and the light will turn on 100% brightness.



The light turns on at full or dims to maintain lux level. The light output regulates according to the level of natural light available.

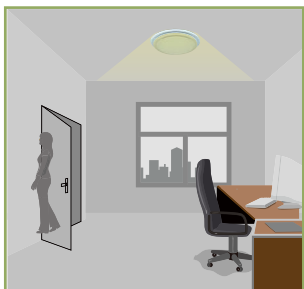

The light dims to stand-by period after hold-time and stays on selected minimum dimming level.

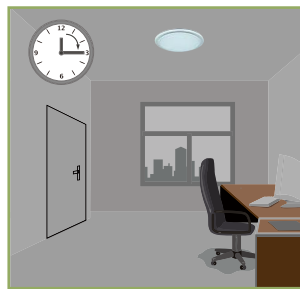

The light switches off completely after the stand-by period.

SETTING ON THIS DEMONSTRATION

- BRIGHTNESS: 100%
- SENSITIVITY: 100%
- HOLD TIME: 30MIN
- DAYLIGHT SENSOR: 👁️
- STAND-BY DIM: 30%
- STAND-BY TIME: 1MIN





BI-LEVEL SENSOR (CONTINUED)

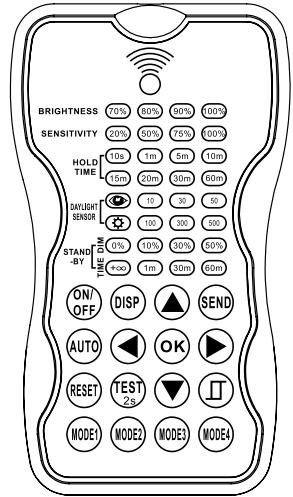



















REMOTE CONTROL OPERATION



LED INDICATORS

LED	DESCRIPTION
BRIGHTNESS	High end trim turning function (To set the output level of connected lighting during occupancy)
SENSITIVITY	To set the occupancy sensing sensitivity of the sensor
HOLD TIME	The time that the sensor will turn off (if you choose stand-by level is 0) or dim the light to a low level after the area is vacated
DAYLIGHT SENSOR	To represent various thresholds of natural light level for the sensor
	To select the current surrounding lux value as the daylight threshold. This feature enables the fixture to function well in any real application circumstances.
	The daylight sensor stops working, and all motion detected could turn on the lighting fixture, no matter how bright the natural light is.
STAND-BY DIM	To set the output level of connected lighting during vacancy. The sensor will regulate the lighting output at the set level. Setting the STAND-BY DIM level at 0 means light is fully off during vacancy.
STAND-BY TIME	To represent the time that the sensor will keep the light at low dim level after the HOLD TIME elapsed.

BUTTON OPERATIONS

BUTTON	DESCRIPTION
	Press the  button, the light goes to permanent on or permanent off mode, and the sensor is disabled. (MUST press  button to quit this mode for setting).
	Display the current/latest setting parameters in LED indicators (the LED indicators will on for showing the setting parameters).
	Press  button to reset all settings to the setting of dip switch in the sensor.
	Enter in the setting condition, the parameter LEDs of remote control will flash to be selected, and navigate to UP and DOWN to choose selected parameters in LED indicators.
	Confirm the selected parameters in remote control.
	Press  button to upload the current parameters to sensor(s). The LED light which the sensor connects to will turn on and off as confirmation.
	Four scene modes with preset parameters which are user configurable and can be saved as a mode.
	Press  button for the sensor to start functioning. All settings remain the same as the latest status before the light switched to ON/OFF mode.
	The button  is for testing purpose sensitivity only. After you choose sensitivity thresholds, then you press  button. The sensor goes to test mode (hold time is only 2s) automatically. Meanwhile, the stand-by period and daylight sensor are disabled. Press  button to quit from this mode.
	Navigate to LEFT and RIGHT for choosing selected parameters in LED indicators.
	Open and close smart daylight sensor. Press  Enter in the setting condition, the parameter LEDs of remote control will flash to be selected, Press  for open or close smart daylight sensor

