

IMPORTANT SAFETY PRECAUTIONS

Before you begin, read these instructions completely and carefully.

- Be certain electrical power is OFF before and during installation, maintenance and removal.
- Luminaire wiring must be properly grounded in accordance with the NEC and any applicable local code requirements.
- Use only UL or IEC approved wire for input/output connections.
- Verify that supply voltage matches voltage on luminaire label. Installation to any other connection may void the warranty.
- Wear gloves during installation to prevent injury and do not expose wiring to metal or sharp edges.
- Do not install in areas subject to combustible vapors or gases. Verify luminaire location ratings are suitable for installation environment (refer to specification sheet as needed).
- Do not restrict luminaire's ventilation by covering with material that will cause luminaire to overheat and potentially shorten the life span.
- Ensure LED luminaire has the correct polarity before installation.



WARNING: To reduce the risk of personal injury or property damage from fire, electrical shock, falling parts, abrasions, burns and all other hazards, read all provided warnings and follow installation instructions.

This product should be installed, inspected and maintained by a qualified and licensed electrician. Installation of luminaire must be in accordance with NEC and local code requirements.

SAVE THESE INSTRUCTIONS



DIMENSIONS

SIZES 5

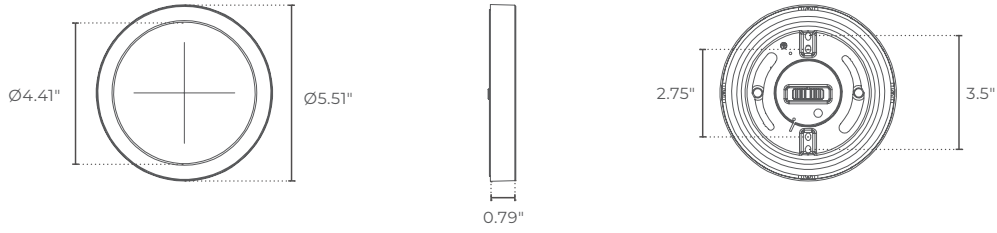

SIZES 7

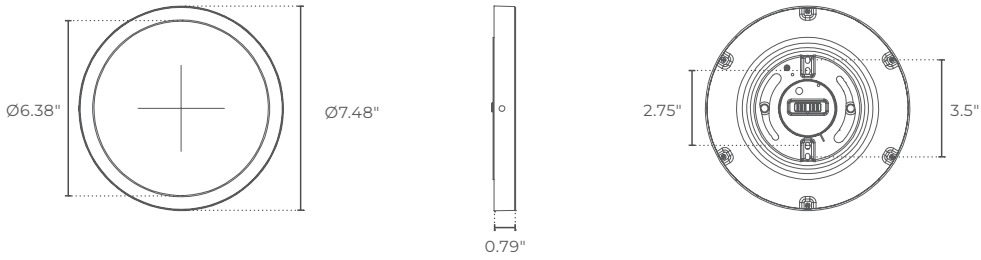

SIZES 9

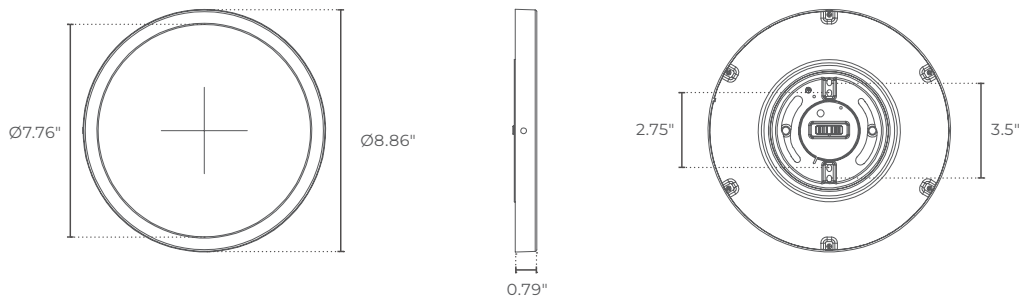

SIZES 11

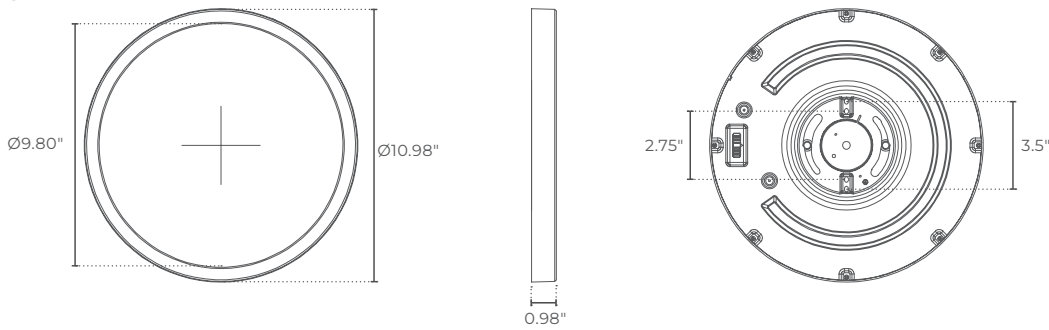

SIZES 13

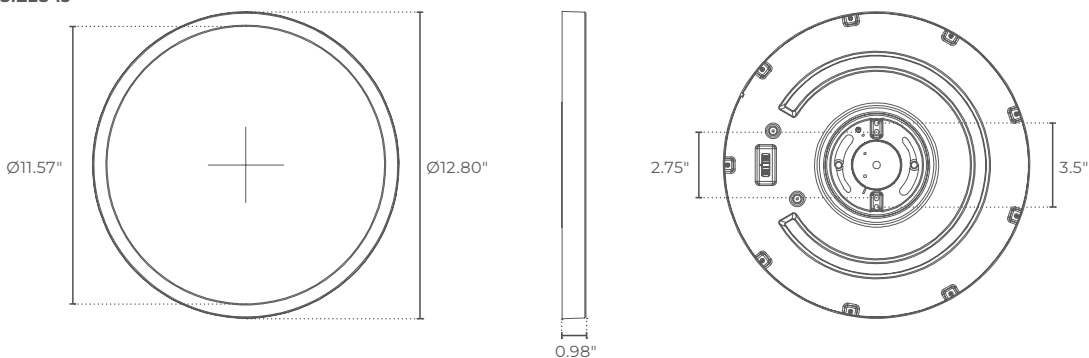

SAVE THESE INSTRUCTIONS



READ AND FOLLOW SAFEETY INSTRUCTIONS

GENERAL: The electrical connections must be in accordance with local and National Electrical Code(N.E.C.) standards. If you are unfamiliar with proper electrical wiring connections, obtain the service of a qualified electrician.

1. Do not make or alter any opened holes in an enclosure of wiring or electrical components during kit installation.
2. To prevent wiring damage or abrasion, do not expose wiring to edges of sheet metal or other sharp objects.
3. Suitable for wet location.
4. This device is not intended for use with emergency exit.
5. This fixture is dimmable. Dimming range is 10%-100%. Please refer to recommended dimmers list.

RECOMMENDED DIMMERS

LEVITON MODELS

- 6672
- 6674
- DSL06
- RNL06
- IPL06

LUTRON MODELS

- TG-600PR-WH
- S-600PR-WH
- CTCL-153PDH-WH
- TGCL-153PH-LA
- SLV-600P-AL
- DV-600PR-WH

- SCL-153PH-WH
- GT-600P
- DVCL-153P

- MSCL-OP153M
- MACL-153M/MA-R
- PD-6WCL

PACKAGE CONTENTS (FOR SIZE 5, 7, & 9)

Part	Description	Qty
A	SPR-WL Fixture	1
B	Mounting Bracket	1
C	Wire Nuts	3
D	J-Box Screws	2

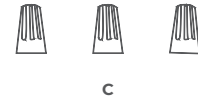
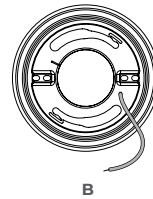
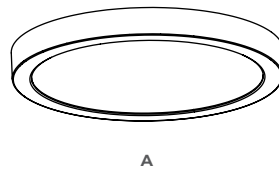

PACKAGE CONTENTS (FOR SIZE 11 & 13)

Part	Description	Qty
A	SPR-WL Fixture	1
B	Bracket	1
C	Wire Nuts	3
D	Screws	2

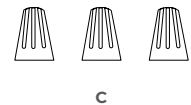
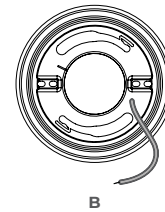
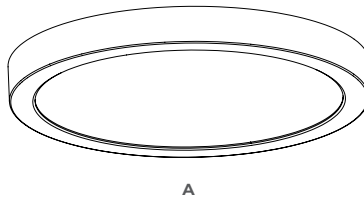

SAVE THESE INSTRUCTIONS



INSTALLATION INSTRUCTIONS (FOR SIZE 5, 7, & 9)

A) Make sure power is off and the J-BOX is securely mounted before installing the fixture.

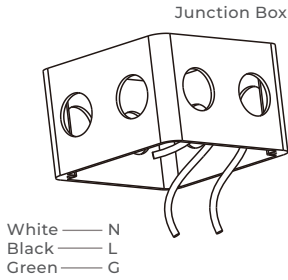

B) Refer to the hole position on the bracket and do the matching j-box. Attach them with screws.

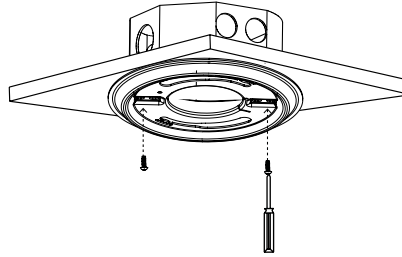

C) Select desired color temperature with the CCT Switch.

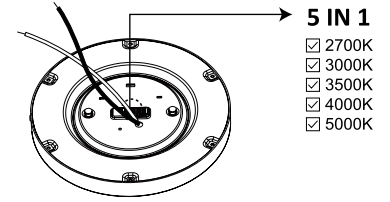

D) Connect the supply wires to wires on fixture/ bracket with wire nuts. Attach white to white, black to black, and copper wire to green wire as grounding connection.

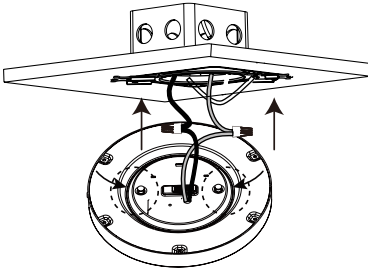

E) Arrange the wires into the J-Box. Align the 2 screw points on fixture to the wider side of long holes on the bracket, twist in clockwise direction until fixing stable. Turn on the power after installation. Ensure the fixture is functioning.

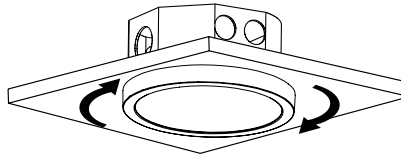

INSTALLATION INSTRUCTIONS (FOR SIZE 11 & 13)

A) Make sure power is off and j-box is securely mounted before installing the fixture, see Fig1

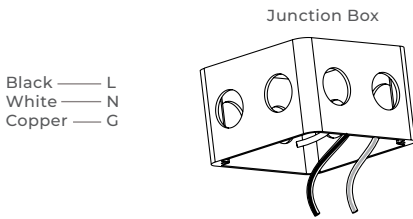

B) Refer to the hole position on the bracket and align with j-box. Secure with provided screws.

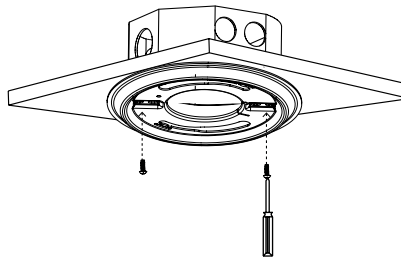

C) Select desired CCT via dipswitch

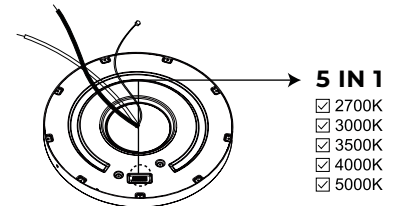

D) Make wiring connections using provided wirenuts.

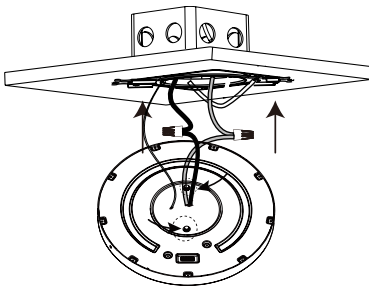

E) Push wires into j-box. Align the 2 screw points on the fixture to the wider side of the cutouts on the bracket, twist in clockwise direction until secure.

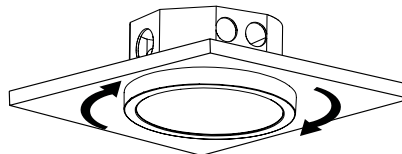

SAVE THESE INSTRUCTIONS

