

PROJECT DATE

COMMENTS



IN STOCK



FS1

FS2



FS3

ENERGY CHART

WATTAGE	BUG (BUG WITH GLARE SHIELD)	DELIVERED LUMENS	EFFICACY lm/w	VOLTAGE/CURRENT INPUT	
				120V	277V
80W	B3-U0-G3	12,000	150	0.66A	0.28A
100W	B3-U0-G3 (G3-U0-G1)	13,000	150	0.83A	0.36A
150W	B3-U0-G3	22,500	150	1.25A	0.54A
200W	B4-U0-G4	30,000	150	1.66A	0.72A
240W	B4-U0-G4	36,000	150	2.00A	0.72A
300W	B4-U0-G4	45,000	150	2.50A	1.08A
300W	B5-U0-G5	48,000	160	2.50A	1.08A
350W	B5-U0-G5	56,000	160	2.92A	1.26A
400W	B5-U0-G5	64,000	160	3.33A	1.44A
450W	B5-U0-G5	72,000	160	3.75A	1.62A
500W	B5-U0-G5	80,000	160	4.16A	1.81A

PLPS-QS PARKING LOT PERFORMANCE SELECTABLE LED QUICK SHIP

The PLPS-QS Parking Lot Performance Selectable LED is a quick ship, high-output area luminaire engineered for parking lots, site lighting, auto dealerships, and large commercial applications. Featuring field-selectable wattage and CCT in a single fixture, the PLPS-QS delivers up to 160 lm/W and up to 80,000 lumens with Type III, IV, and V distributions for optimized site coverage. A standard 0-10V dimmable driver and surge protection ensure long-term performance in demanding outdoor environments. Constructed with a heavy-duty die-cast aluminum housing and polycarbonate lens, PLPS-QS is IP65 rated for wet locations and operates in temperatures from -20°C to 45°C. Multiple mounting options provide flexible installation across pole and wall applications.

- Dimming & Surge Protector Standard
- Multiple Mounting Options

PHYSICAL

Material	Heavy-duty die-cast aluminum with corrosion-resistant powder coat finish
Mounting	Slip Fitter, Adjustable Arm Mount, Yoke Bracket
Lens	High-impact UV-stabilized polycarbonate lens
Finish	Bronze, White

PERFORMANCE

Warranty	5-Year Limited Warranty
Certifications	UL, DLC Premium, Wet Location
IP Rating	IP65
CCT	Field Selectable: 3000K/4000K/5000K
CRI	>80
Distribution	Type III, Type IV, Type V
Rated Life	L80 50,000 hours
Operating Temperature	-20°C to 45°C (-4°F to 113°F)
Operating Humidity	20% – 90% RH

ELECTRICAL

Wattage	Field Selectable by Model: 80W/100W/150W, 200W/240W/300W, 300W/350W/400W/450W/500W
Voltage	100-277V, 200-480V
Dimmable	0-10V
Surge Protector	8kV (Standard)
Power Factor	≥0.9
THD	≤20%

ORDERING LOGIC ON PAGE 2



ORDERING LOGIC

EX: PLPS-QS-FS1-12-FS3-3-BZ-SF-PC

FAMILY	WATTAGE	VOLTAGE	CCT	DISTRIBUTION	FINISH
PLPS-QS			FS3		
FS1	80W/100W/150W Selectable <small>WATTAGE SELECTABLE VIA INTERNAL SWITCH</small>	12 120-277V	FS3 Field Selectable <small>3000K / 4000K / 5000K</small>	3 Type 3	BZ Bronze
FS2	200W/240W/300W Selectable <small>WATTAGE SELECTABLE VIA INTERNAL SWITCH</small>	48 200-480V		4 Type 4	WH White
FS3	300W/350W/400W/450W/500W Selectable <small>WATTAGE SELECTABLE VIA INTERNAL SWITCH</small>			5 Type 5	BK Black

MOUNTING

OPTIONS

ORDERING NOTES

* Photocell available with FS1 and FS2 wattage platforms only.

SF Slip Fitter

PC* Photocell

AM Adjustable Arm Mount

YB Yoke Bracket

ACCESSORIES ORDERING LOGIC

EX: PLPS-QS-GS-BK-FS1

FAMILY	ACCESSORIES
PLPS-QS	
GS-BK-FS1	Glare Shield for FS1 - Black Finish
GS-BK-FS2	Glare Shield for FS2 - Black Finish
GS-BK-FS3	Glare Shield for FS3 - Black Finish
GS-BZ-FS1	Glare Shield for FS1 - Bronze Finish
GS-BZ-FS2	Glare Shield for FS2 - Bronze Finish
GS-BZ-FS3	Glare Shield for FS3 - Bronze Finish
GS-WH-FS1	Glare Shield for FS1 - White Finish
GS-WH-FS2	Glare Shield for FS2 - White Finish
GS-WH-FS3	Glare Shield for FS3 - White Finish

PHOTOCELL

Photocell available with **FS1** and **FS2** wattage platforms only.



GLARE SHIELD



DIMENSIONS

FS1

Slip Fitter

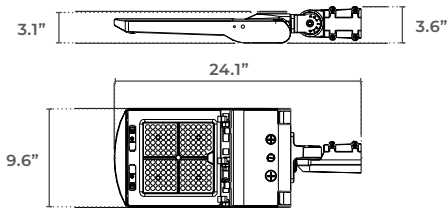

Adjustable Arm Mount

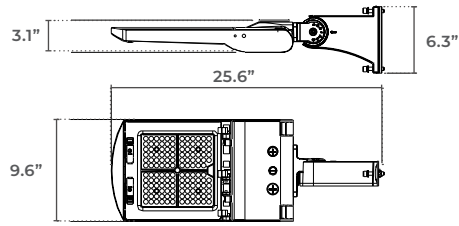

Yoke Bracket

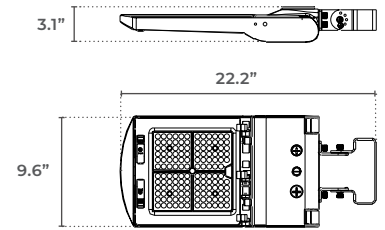

FS2

Slip Fitter

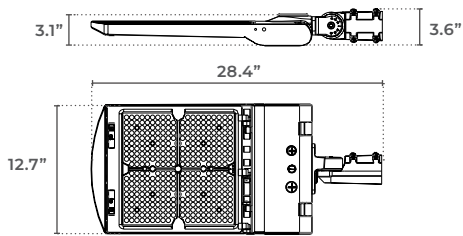

Adjustable Arm Mount

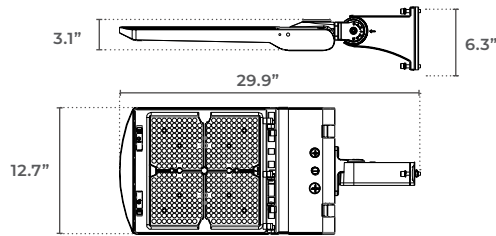

Yoke Bracket

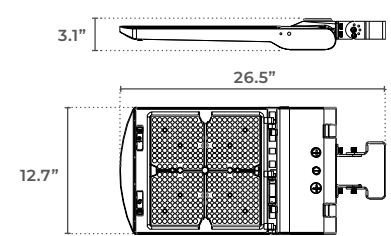

FS3

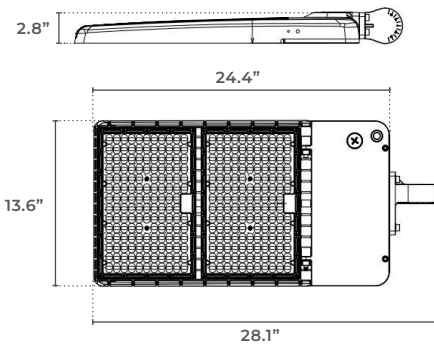

MOUNTING

SF Slip Fitter



AM Adjustable Arm Mount



YB Yoke Bracket



PHOTOMETRICS - PLPS-QS - FS1 - 80W - 12000LM - 5000K

AVERAGE BEAM ANGLE (50%): 122°

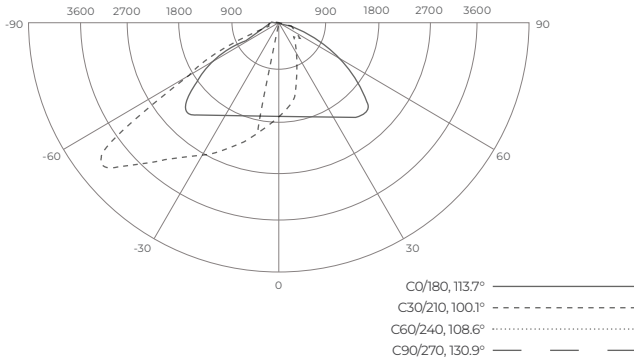

PHOTOMETRICS - PLPS-QS - FS1 - 100W - 15000LM - 5000K

AVERAGE BEAM ANGLE (50%): 122°

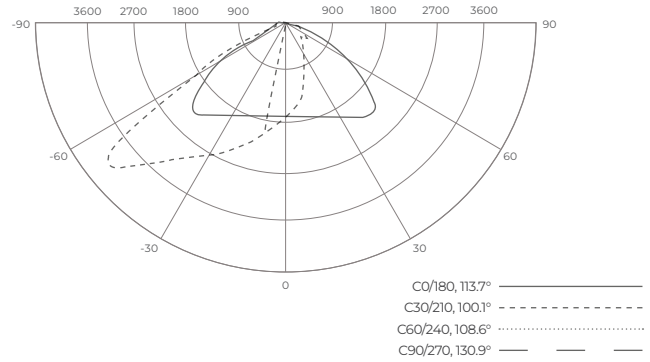

PHOTOMETRICS - PLPS-QS - FS1 - 150W - 22500LM - 5000K

AVERAGE BEAM ANGLE (50%): 122°

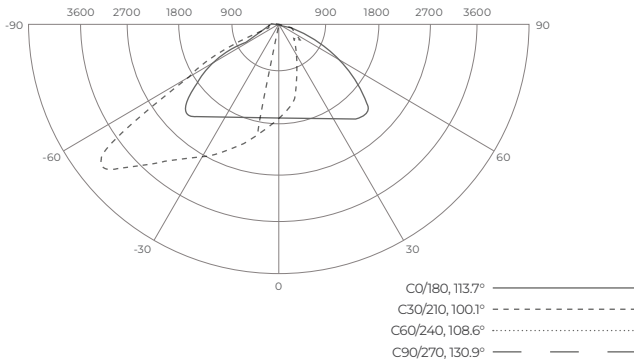

PHOTOMETRICS - PLPS-QS - FS2 - 200W - 30000LM - 5000K

AVERAGE BEAM ANGLE (50%): 122°

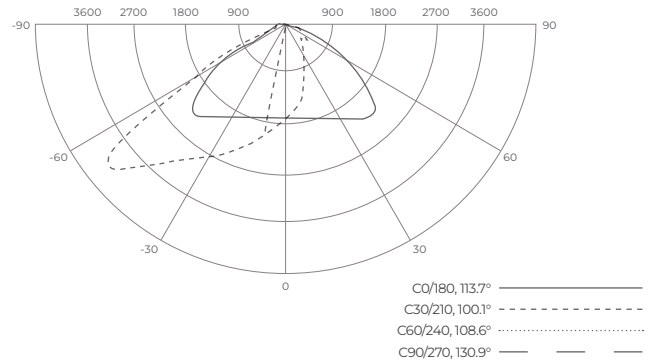

PHOTOMETRICS - PLPS-QS - FS2 - 240W - 36000LM - 5000K

AVERAGE BEAM ANGLE (50%): 122°

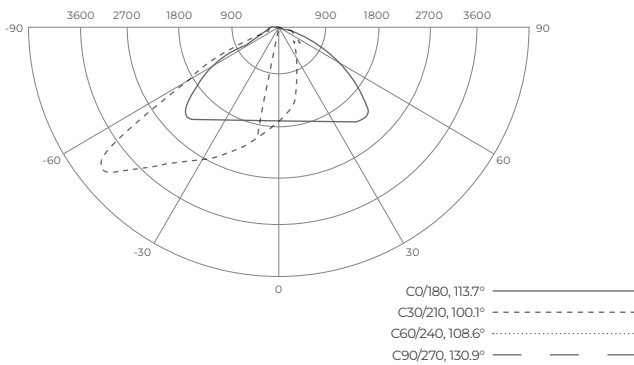

PHOTOMETRICS - PLPS-QS - FS2 - 300W - 45000LM - 5000K

AVERAGE BEAM ANGLE (50%): 122°

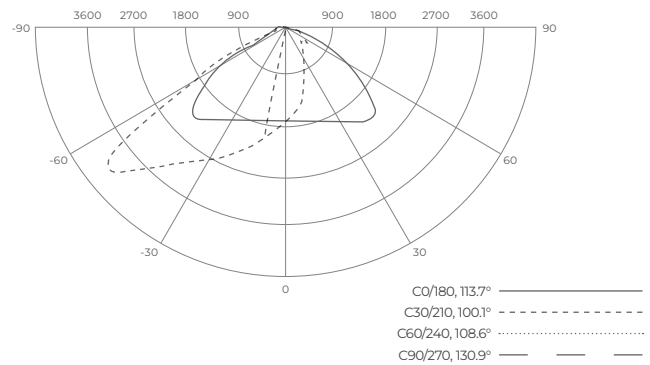

PHOTOMETRICS - PLPS-QS - FS3 - 300W - 48000LM - 5000K

AVERAGE BEAM ANGLE (50%): 122°

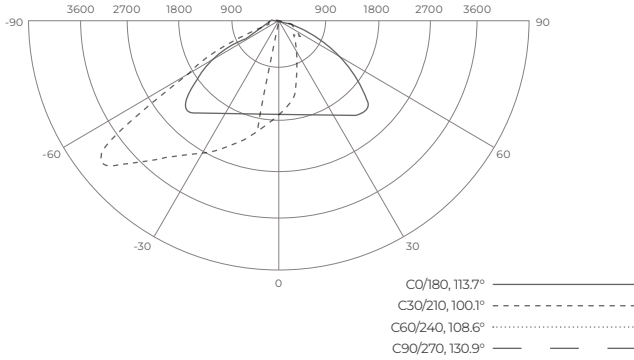

PHOTOMETRICS - PLPS-QS - FS3 - 350W - 56000LM - 5000K

AVERAGE BEAM ANGLE (50%): 122°

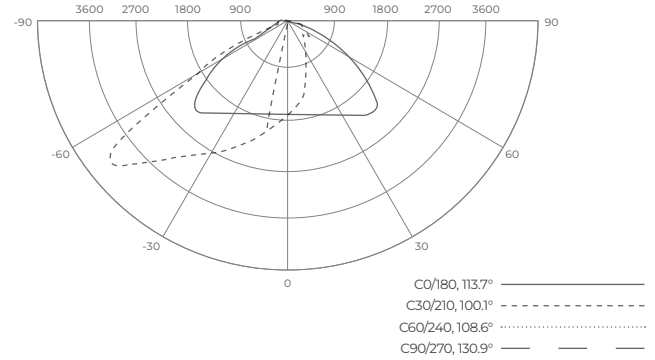

PHOTOMETRICS - PLPS-QS - FS3 - 400W - 64000LM - 5000K

AVERAGE BEAM ANGLE (50%): 122°

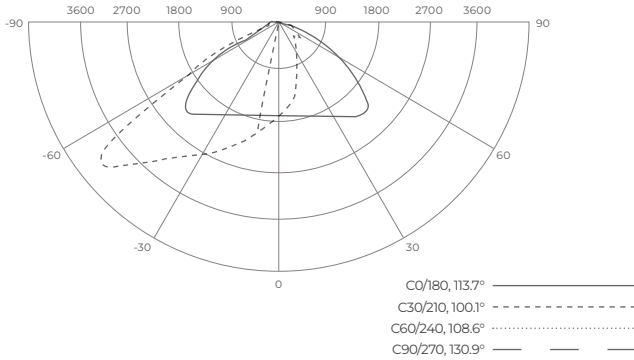

PHOTOMETRICS - PLPS-QS - FS3 - 450W - 72000LM - 5000K

AVERAGE BEAM ANGLE (50%): 122°

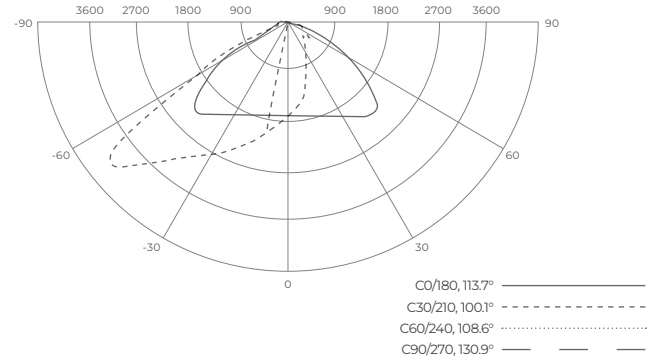

PHOTOMETRICS - PLPS-QS - FS3 - 500W - 80000LM - 5000K

AVERAGE BEAM ANGLE (50%): 122°

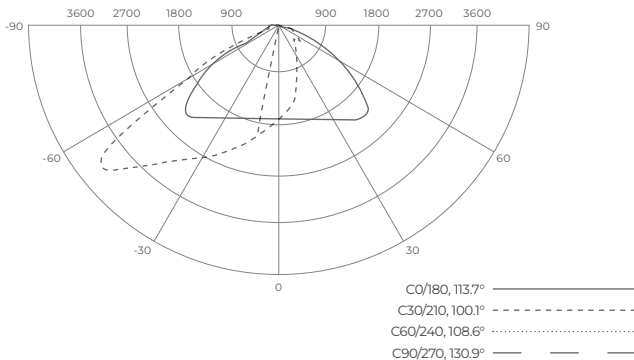

FIELD SELECTABLE FUNCTIONS

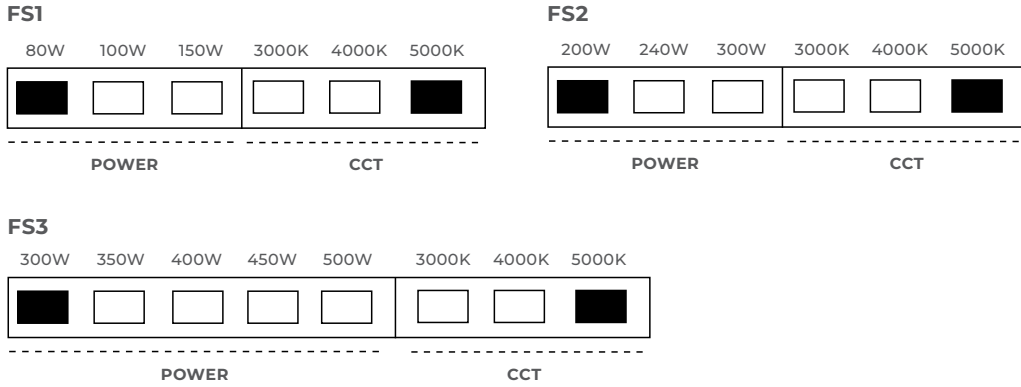

FS3 FEATURES

