



IMPORTANT SAFETY PRECAUTIONS

Before you begin, read these instructions completely and carefully.

- Be certain electrical power is OFF before and during installation, maintenance and removal.
- Luminaire wiring must be properly grounded in accordance with the NEC and any applicable local code requirements.
- Use only UL or IEC approved wire for input/output connections.
- Verify that supply voltage matches voltage on luminaire label. Installation to any other connection may void the warranty.
- Wear gloves during installation to prevent injury and do not expose wiring to metal or sharp edges.
- Do not install in areas subject to combustible vapors or gases. Verify luminaire location ratings are suitable for installation environment (refer to specification sheet as needed).
- Do not restrict luminaire's ventilation by covering with material that will cause luminaire to overheat and potentially shorten the life span.



WARNING: To reduce the risk of personal injury or property damage from fire, electrical shock, falling parts, abrasions, burns and all other hazards, read all provided warnings and follow installation instructions.

This product should be installed, inspected and maintained by a qualified and licensed electrician. Installation of luminaire must be in accordance with NEC and local code requirements.

SAVE THESE INSTRUCTIONS



DIMENSIONS

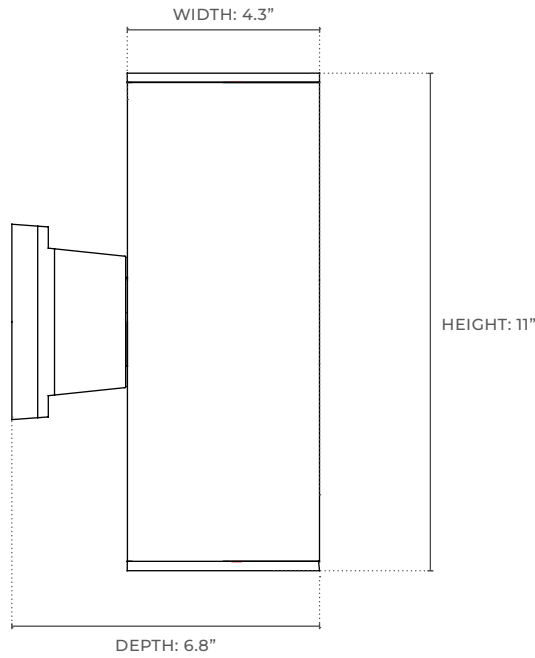

TOOLS REQUIRED

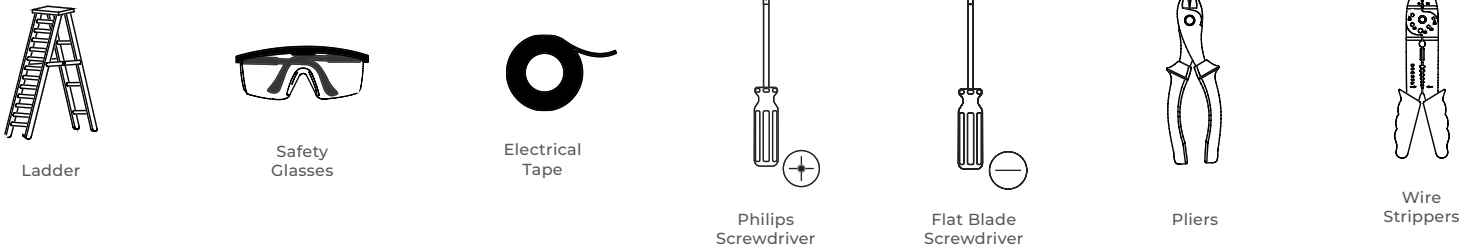

HARDWARE INCLUDED

NOTE: Hardware not shown to actual size.

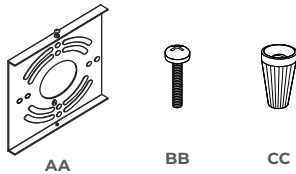

PART	PART DESCRIPTION	QTY
AA	Mounting Bracket	1
BB	Mounting Screw	2
CC	Wire Nut	3

PACKAGE CONTENTS

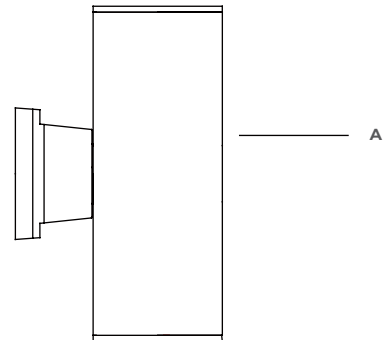

PART	PART DESCRIPTION	QTY
A	Light Fixture	1

SAVE THESE INSTRUCTIONS



INSTALLATION INSTRUCTIONS

1) Attaching the Mounting Unit to the Junction Box

- Remove the two pre-assembled screws and washers from the mounting bracket (AA).
- Screw the outlet box screws (BB) through the holes on the mounting bracket (AA) into the screw holes on the outlet box.

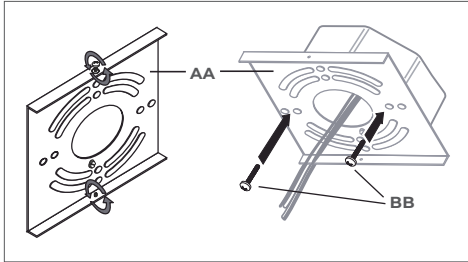

2) Making the Electrical Connections

- Connect the copper wire from the light fixture (A) to the mounting bracket (AA) by securing it with the pre-installed ground screw.
- Connect the black wire from the fixture to the black wire from the outlet box, the white wire from the fixture to the white wire from the outlet box, and the copper wire from the fixture to the ground wire from the outlet box with the wire nuts (CC). Secure with electrical tape (not included).

NOTE: If the wires from the fixture are the same color, attach the side with markings or letters to the black (positive) wire and the other to the white (neutral) wire.

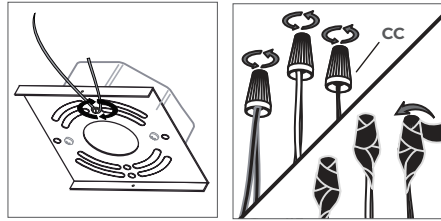

3) Securing the Light Fixture

- After wires are connected, tuck them carefully inside the junction box.
- Put the fixture body (A) over the mounting bracket (AA).
- Secure the light fixture with two previously-removed screws and washers.

CAUTION: To avoid any waterproofing problems, make sure the light fixture fits the mounting surface perfectly during installation and use waterproof glue around the canopy for better sealing after installation.

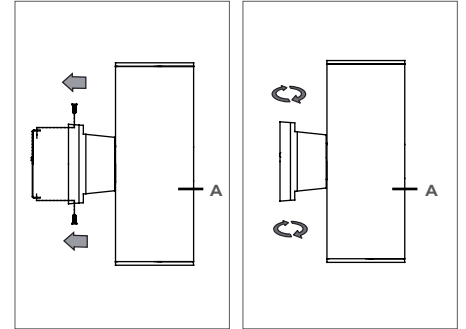

SAVE THESE INSTRUCTIONS

