

IMPORTANT SAFETY PRECAUTIONS

Before you begin, read these instructions completely and carefully.

- Be certain electrical power is OFF before and during installation, maintenance and removal.
- Luminaire wiring must be properly grounded in accordance with the NEC and any applicable local code requirements.
- Use only UL or IEC approved wire for input/output connections.
- Verify that supply voltage matches voltage on luminaire label. Installation to any other connection may void the warranty.
- Wear gloves during installation to prevent injury and do not expose wiring to metal or sharp edges.
- Do not install in areas subject to combustible vapors or gases. Verify luminaire location ratings are suitable for installation environment (refer to specification sheet as needed).
- Do not restrict luminaire's ventilation by covering with material that will cause luminaire to overheat and potentially shorten the life span.









WARNING: To reduce the risk of personal injury or property damage from fire, electrical shock, falling parts, abrasions, burns and all other hazards, read all provided warnings and follow installation instructions.

This product should be installed, inspected and maintained by a qualified and licensed electrician. Installation of luminaire must be in accordance with NEC and local code requirements.

SAVE THESE INSTRUCTIONS



TOOLS REQUIRED

DESCRIPTION	PART
Tape Measure	
Level	
Pencil	
Drill	
Phillips (cross-head) screwdriver	
Hammer	

INSTALLATION INSTRUCTIONS
STEP 1 — DISCONNECT POWER

Turn off the main power supply at the circuit breaker.

STEP 2 — MARK MOUNTING LOCATIONS

Position the metal mounting cleat on the wall at the desired height. Ensure it is level, then mark the screw hole locations (see diagram on page 2 of source file).

STEP 3 — DRILL AND INSTALL HARDWARE

Drill holes at the marked points. Insert the provided wall anchors. Secure the mounting cleat to the wall using the supplied screws. (Reference illustrations on page 2 of source file.)

STEP 4 — ELECTRICAL CONNECTIONS

Align the fixture canopy over the mounting screws so they slide through the keyhole slots. Rotate slightly until secure, then tighten screws until snug against the ceiling.

STEP 5 — HANG THE MIRROR

Lift the mirror and hang it onto the wall cleat. Ensure it is fully seated and securely engaged with the cleat (see diagram on page 2 of source file).

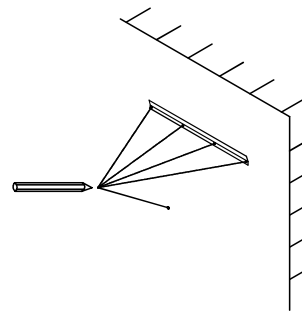

STEP 2

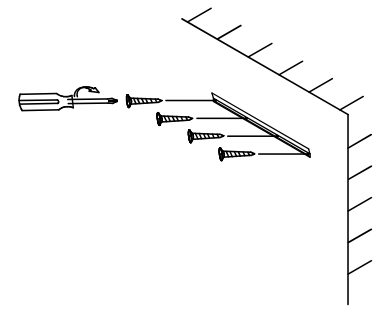

STEP 3

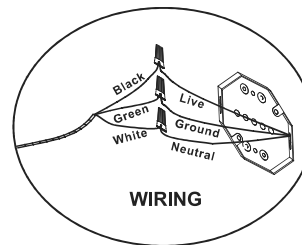
WIRING

STEP 4

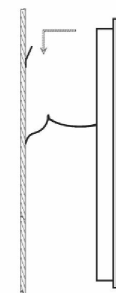

STEP 5

MAINTENANCE

- Clean the mirror with a soft, dry cloth only.
- Do not use chemical cleaners or abrasives.

SAVE THESE INSTRUCTIONS
