

PROJECT \_\_\_\_\_ DATE \_\_\_\_\_

COMMENTS \_\_\_\_\_



Trim



Trimless

### ENERGY CHART

SIZE inches	WATTAGE	30° BEAM ANGLE		50° BEAM ANGLE	
		DELIVERED LUMENS	EFFICACY (lm/w)	DELIVERED LUMENS	EFFICACY (lm/w)
2	5W	335	67	365	73
2	8W	544	68	592	74
2	10W	670	67	740	74
2	13W	832	64	910	70
2	16W	976	61	1072	67
2	19W	1121	59	1235	65

## SPUR-2 2" ARCHITECTURAL DOWNLIGHT LED

The SPUR-2 is a precision-engineered 2" architectural LED downlight delivering exceptional performance in a compact aperture. Built on a modular twist-and-lock platform with interchangeable optics, SPUR-2 offers field-selectable wattage and dual dimming compatibility (0-10V dimming to 1% and TRIAC). Available with 90+ CRI fixed CCT options or 95+ CRI Dim-to-Warm, SPUR-2 is ideal for residential, hospitality, retail, and commercial spaces requiring discreet, high-quality illumination.

- Residential
- Commercial
- Hospitality

### PHYSICAL

Material	Aluminum housing / die-cast aluminum (heat-sink body)
Mounting	Interchangeable optics (standard or low-glare lens)
Lens	Recessed (Remodel, New Construction Frame Kit, or IC Housing Kit)
Reflector	Classic reflector-inspired optical design; interchangeable optics
Finish	Powder coat White or Black (trim dependent)

### PERFORMANCE

Warranty	5 years
Certifications	cULus listed for damp locations; IC-rated option (with IC housing)
IP Rating	Damp Location
Rated Life	L70 > 50,000 hours
Operating Temperature	-20°C to +40°C (-4°F to 104°F)
CCT	2700K / 3000K / 3500K / 4000K or Dim-to-Warm (3000K-2000K)
CRI	90+ (Fixed CCT) or 95+ (Dim-to-Warm)
Beam Angle	30°, 50° (2" high-efficiency optics)

### ELECTRICAL

Wattage	5-19W (field selectable)
Voltage	110-277V AC (driver dependent); TRIAC 120V only
Power Factor	>0.9
Dimmable	0-10V (dims to 1%) and TRIAC
THD	<20%

ORDERING LOGIC ON NEXT PAGE





**ORDERING LOGIC**

EX: SPUR-2-19-30-RO-RW-R

FAMILY	WATTAGE	CCT	BEAM ANGLE	TRIM
<b>SPUR-2</b>	<b>19</b>			
	<b>19<sup>1</sup></b> 5-19W Field Selectable	<b>27</b> 2700K <small>(90+ CRI)</small>	<b>30</b> 30°	<b>RO</b> Round Open - White
		<b>30</b> 3000K <small>(90+ CRI)</small>	<b>50</b> 50°	<b>BO</b> Round Open - Black
		<b>35</b> 3500K <small>(90+ CRI)</small>		<b>TL</b> Trimless Round (Spackle-In)
		<b>40</b> 4000K <small>(90+ CRI)</small>		
		<b>DT</b> Dim-to-Warm 3000K-2000K <small>(95+ CRI, 13W MAX)</small>		

TRIM SHADE <sup>2</sup>	INSTALL TYPE <sup>3</sup>
<b>RW</b> White	<b>R</b> Retrofit <small>(NON-IC)</small>
<b>RB</b> Black	<b>NF</b> New Construction — Frame Kit <small>(NON-IC)</small>
<b>RG</b> Gold	<b>NC</b> New Construction — Housing Insulation Kit <small>(IC)</small>
<b>RC</b> Chrome	

**ORDERING NOTE**

1. Wattage is field-selectable at installation (5W, 8W, 10W, 13W, 16W, 19W).
2. Trim shade finish options (select one).
3. IC option requires IC housing insulation kit.

**ACCESSORIES ORDERING LOGIC (ORDER SEPARATELY)**

EX: SPUR-3-HB

FAMILY	ACCESSORIES
<b>SPUR-2</b>	
<b>HB</b>	Honeycomb <small>(ONLY FOR ROUND/SQUARE SHADE)</small>
<b>WR</b>	Waterproof Plate (Wet Rated) For Round Shade
<b>EM</b>	Emergency Field-install 16W LED Emergency Driver
<b>DYB</b>	Decorative Kit – Yellow <small>(BLACK FACE PLATE)</small>
<b>DYW</b>	Decorative Kit – Yellow <small>(WHITE FACE PLATE)</small>
<b>DRB</b>	Decorative Kit – Red <small>(RED FACE PLATE)</small>
<b>DGB</b>	Decorative Kit – Green <small>(BLACK FACE PLATE)</small>
<b>DGW</b>	Decorative Kit – Green <small>(WHITE FACE PLATE)</small>
<b>DTB</b>	Decorative Kit – Transparent <small>(BLACK FACE PLATE)</small>
<b>DTW</b>	Decorative Kit – Transparent <small>(WHITE FACE PLATE)</small>
<b>DBB</b>	Decorative Kit – Blue <small>(BLACK FACE PLATE)</small>
<b>DBW</b>	Decorative Kit – Blue <small>(WHITE FACE PLATE)</small>



## SPECIFICATIONS

### LED SYSTEM

**LED:** Powered by CREE or Bridgelux high efficiency COB LED chip.

**CRI:** 90+ for fixed CCT or 95+ CRI for Dim to Warm, producing outstanding illumination at a tight chromaticity specification and color binning process.

**CCT:** 2700K, 3000K, 3500K and 4000K fixed CCT with a great color consistency or Dim to Warm from 3000K to 2000K.

**Light Engine Heatsink:** Aluminum housing acting as the heat sink to maximize life. The temperature of all heatsinks are controlled at 60-70°C.

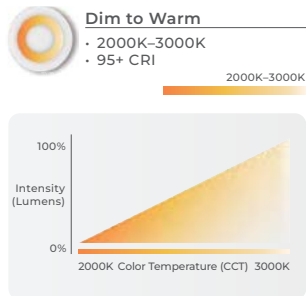
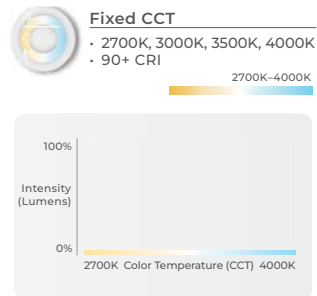

### OPTICS

Classic reflector-like design provides high lighting transmittance. It effect in light control and anti-glare with side facula and fade-out facula. The MR16 standard size (diameter 1.96") design make them widely practical. Available in 30° and 50° beam angles, beam spreads are interchangeable which can be easily swapped out in the field without tools.

### TRIM FINISH / SHADE

Powder coat white and black finishes offer uniform finish providing long term performance and superior aesthetic, compatible for multiple trim shades.



### ELECTRICAL

**LED Driver:** It is powered by Class 2 high efficiency LED driver, with a standard 0-10V dimming which continuous dims to 1% or Triac dimming that works with many types of controls. Thermal overload protection shuts down the luminaire when system temperatures exceed designed operating conditions.

**THD:** <20%

**Power Factor:** >0.9

**Input Voltage:** Standard electronic drivers are cULus recognized and available for 110-277V AC.

**Environment:** Environment damp rated for ambient operating temperature of -20°C to +40°C (-4° to +104°F)

### INSTALLATION

Twist & Lock mechanism for easy trim installation.

Durable tension clips enable fast and easy flush installation.

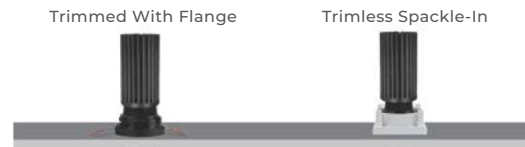

### WARRANTY

Five-year warranty for parts and components. (Labor not included)

### LISTINGS

• cULus listed for damp locations.

### Notes:

- Ambient temperatures at fixture location should not exceed 40°C during normal operation.
- For interior use only

## DIMENSIONS

### ROUND TRIM

Mounting Diameters: 2.2"-2.26"

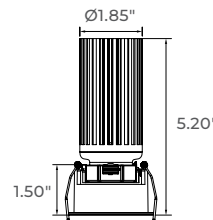

### ROUND TRIMLESS

Mounting Diameters: 3.5"-2.26"

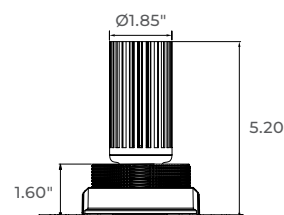
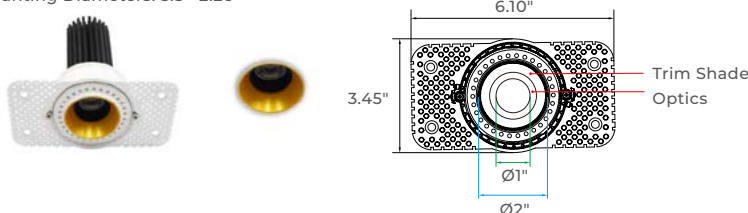



**MOUNTING**

**Remodel (NON-IC)- LED Driver Box**

It can be installed in existing ceilings for remodel application. Simple cut a hole in existing drywall ceilings.

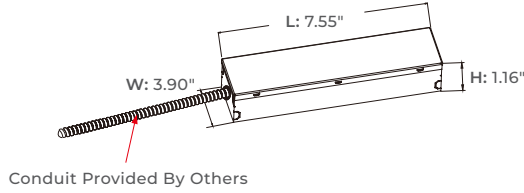
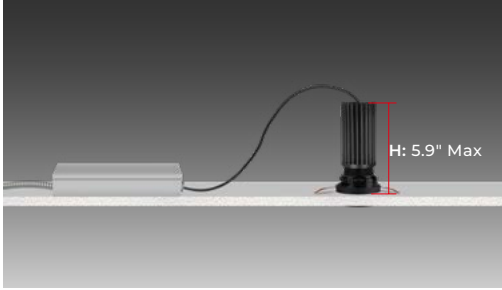

**New Construction-Frame Kit (NON-IC)**

A rough-in frame option is available for all new constructions and a variety of ceiling types. LED driver box rests on the frame kit by magnet when installed as shown below.

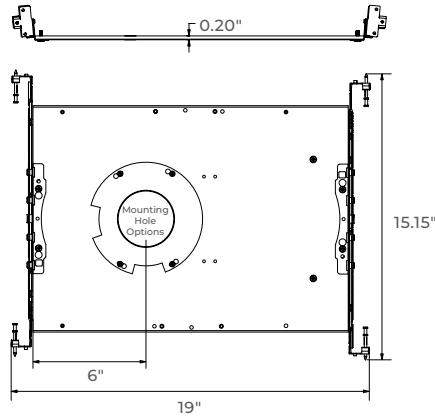

**MOUNTING HOLE OPTIONS**

**ROUND TRIM**

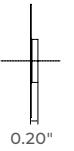
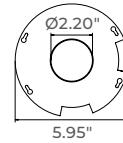

**ROUND TRIMLESS**

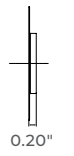
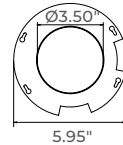

**New Construction-Housing Insulation Kit (IC)**

An IC-rated housing frame kit allows placement of 3inch LED downlight in direct contact with insulation.

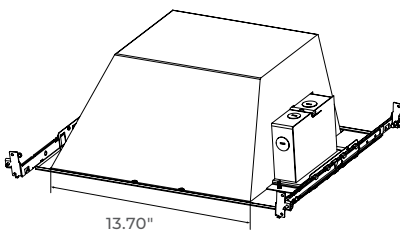
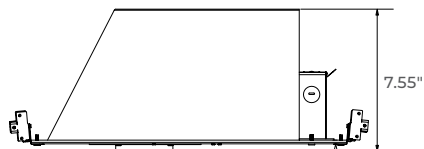
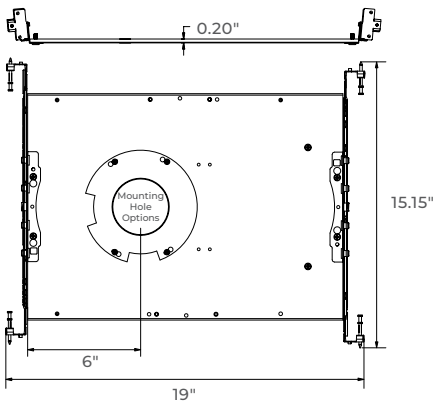



**PHOTOMETRICS - 2" - 10W - 3000K - 50°**

AVERAGE BEAM ANGLE (50%): 44.7°

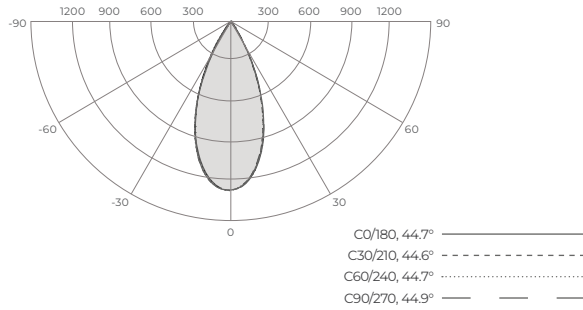

**Luminance cd/(m2)**

G(DEG)	C0/180	C90/270
85	155	312
80	340	899
75	1118	1658
70	1723	2191
65	2260	2944
60	3204	3496
55	3327	3276
50	3418	3284
45	5071	6881

**ZONAL FLUX DIAGRAM**

T	C0	C45	C90	C135	C180
10	1103	1098	1108	1136	1149
20	707.5	695.1	709.7	754.8	784.6
30	235.5	250.8	252.5	286.5	288.0
40	28.5	34.08	34.15	43.27	43.93
50	4.399	4.663	4.221	4.627	4.103
60	3.207	3.187	3.495	3.034	3.023
70	1.180	1.284	1.499	1.207	1.123
80	0.1182	0.1257	0.3123	0.0988	0.0806
90	0	0	0	0	0
100	0	0.0317	0	0.0137	0
110	0.2477	0.2844	0.2788	0.2483	0.0813
120	0.8568	0.9700	0.9235	0.8664	0.3527
130	1.926	2.035	2.005	1.900	1.112
140	3.240	3.329	3.313	3.208	2.277
150	4.387	4.428	4.405	4.366	3.568
160	4.907	4.838	4.888	4.897	4.398
170	4.840	4.838	4.906	4.893	4.695
180	4.930	4.919	4.942	4.988	4.903
DEG	LUMINOUS INTENSITY: cd				

**ZONAL LUMEN SUMMARY**

T	Φ TOTAL
0-10	113.9
10-20	377.2
20-30	605.2
30-40	683.9
40-50	696.3
50-60	699.7
60-70	702.0
70-80	702.8
80-90	702.9
90-100	702.9
100-110	703.0
110-120	703.3
120-130	704.2
130-140	705.9
140-150	708.0
150-160	710.0
160-170	711.4
170-180	711.8
	UNIT: lm

**PHOTOMETRICS - 2" - 19W - 3000K - 50°**

AVERAGE BEAM ANGLE (50%): 44.6°

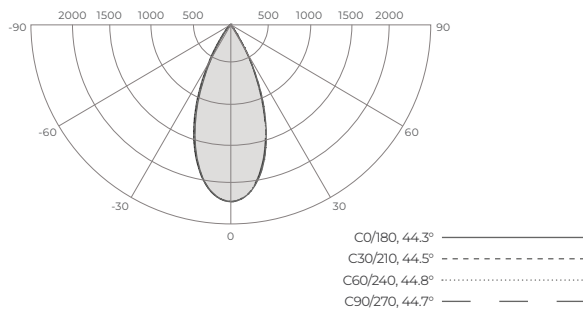

**Luminance cd/(m2)**

G(DEG)	C0/180	C90/270
85	543	1194
80	770	2057
75	2008	3150
70	2977	4299
65	3928	5259
60	5564	5630
55	5734	5537
50	5819	6823
45	9832	16062

**ZONAL FLUX DIAGRAM**

T	C0	C45	C90	C135	C180
10	1973	1972	1952	1948	1952
20	1295	1292	1262	1259	1273
30	454.7	484.9	459.1	464.1	449.4
40	60.28	64.92	61.47	67.22	63.69
50	7.343	8.124	8.805	8.116	7.210
60	5.462	5.451	5.651	5.051	5.292
70	1.999	2.358	2.952	2.111	2.061
80	0.2626	0.3539	0.7171	0.2805	0.2248
90	0.0181	0.0001	0.0274	0.0045	0.0134
100	0.0309	0.0813	0.0679	0.0911	0.0310
110	0.4508	0.4770	0.5197	0.5186	0.1994
120	1.442	1.556	1.651	1.651	0.7404
130	3.252	3.373	3.483	3.523	2.136
140	5.523	5.647	5.773	5.759	4.222
150	7.578	7.651	7.708	7.730	6.400
160	8.554	8.500	8.538	8.578	7.882
170	8.506	8.495	8.547	8.524	8.222
180	8.572	8.652	8.629	8.669	8.612
DEG	LUMINOUS INTENSITY: cd				

**ZONAL LUMEN SUMMARY**

T	Φ TOTAL
0-10	198.8
10-20	656.9
20-30	1051
30-40	1188
40-50	1209
50-60	1215
60-70	1219
70-80	1221
80-90	1221
90-100	1221
100-110	1221
110-120	1222
120-130	1224
130-140	1227
140-150	1230
150-160	1234
160-170	1236
170-180	1237
	UNIT: lm



**ADDITIONAL IMAGERY**



**MOUNTING**



**TRIM SHADES**



White (RW)    Black (RB)    Gold (RG)    Chrome (RC)

**DECORATIVE KIT**



Black Face Plate, Yellow (DYB)    Black Face Plate, Green (DGB)    Black Face Plate, Transparent (DTB)    Black Face Plate, Blue (DBB)    Black Face Plate, Red (DBB)

**ENGINE, OPTICS & TRIM**

